

SMART-Catalog

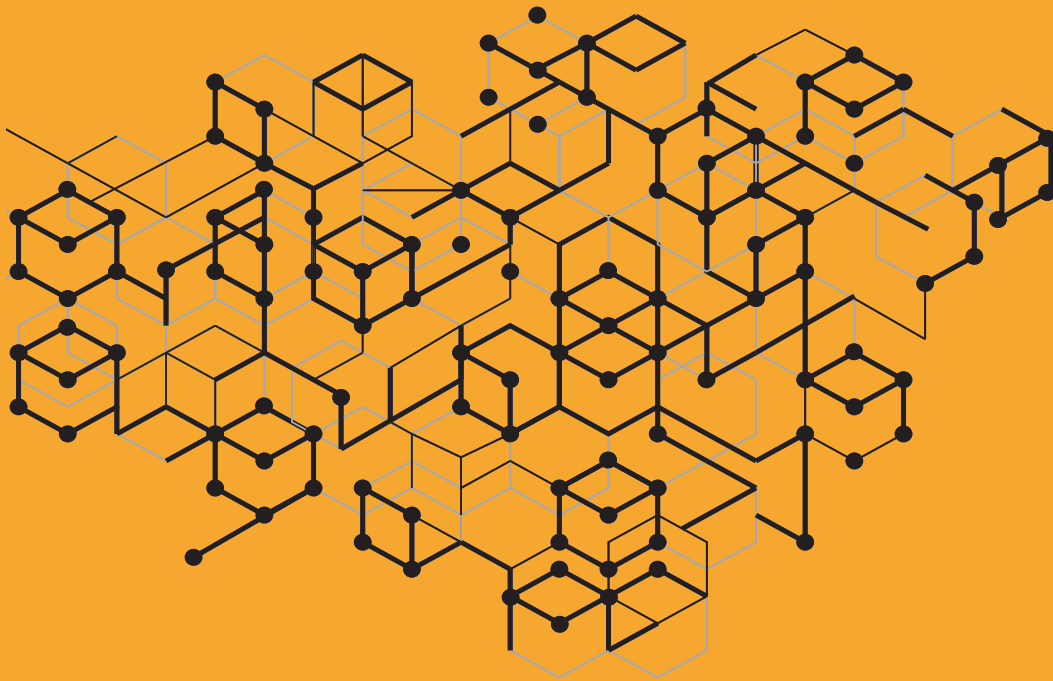

Support system
Cable tray and ladder system
Cable Cleat













IROS
SYSTEM

Contents

Integrated support system "Platform"

 Medium and heavy loads CS/HDG/SS4	3
 Light and medium loads HDG/SS4	5







Cable tray system TMD

 Type TMD-40 1mm R=75 PG/ HDG	7
 Type TMD-40 R=75 PG/ HDG	9
 Type TMD-40 R=75 SS2/SS4	11
 Type TMD-50 R=75 PG/ HDG	13
 Type TMD-50 R=75 SS2/SS4	15
 Type TMD-60 R=75 PG/ HDG.....	17
 Type TMD-60 R=75 SS2/SS4.....	19
 Type TMD-75 R=75 PG/ HDG.....	21
 Type TMD-75 R=75 SS2/SS4.....	23
 Type TMD-100 R=75 PG/ HDG.....	25
 Type TMD-100 R=75 SS2/SS4.....	27









Cable ladder system LLD

 Type LLD-60 R=300 PG/HDG	29
--------------------------------------------------------------------------------------------------------------------	----

Cable ladder system LMD

 Type LMD-60 R=300 HDG/SS4	31
 Type LMD-60 R=600 HDG/SS4	33
 Type LMD-80 R=300 HDG/SS4	35
 Type LMD-80 R=600 HDG/SS4	37
 Type LMD-100 R=300 HDG/SS4.....	39
 Type LMD-100 R=600 HDG/SS4.....	41

Cable ladder system LHD

 Type LHD-100 R=300 HDG/SS4	43
 Type LHD-100 R=600 HDG/SS4	45
 Type LHD-100 R=900 HDG/SS4	47
 Type LHD-125 R=300 HDG/SS4	49
 Type LHD-125 R=600 HDG/SS4	51
 Type LHD-125 R=900 HDG/SS4	53
 Type LHD-150 R=300 HDG/SS4	55
 Type LHD-150 R=600 HDG/SS4	57
 Type LHD-150 R=900 HDG/SS4	59

Fasteners for high voltage cable CFC

Type CFC SS4	61
--------------------	----

Accepted symbols:



PG - pre-galvanized steel

HDG - hot-dip galvanized steel

SS2 - stainless steel, resistance class A* (AISI 304)

SS4 - stainless steel, resistance class D* (AISI 316L)

* - corrosion resistance classification according to GOST R 52868-2021

	Low cable loads
	Average loads from cable and external influences
	High loads from cable and external influences

Support system CS/HDG/SS4



1	START BRACKET WELDED	CS	SS4
1	S-ST-W-L-125x40x5	7553315	7533312
2	S-ST-W-L-200x40x5	7553316	7533313
3	S-ST-W-L-125x90x5-CS	7553311	7533314
4	S-ST-W-L-200x90x5-CS	7553312	7533315
5	S-ST-W-L-300x90x5-CS	7553313	7533316

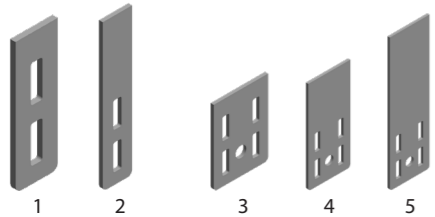

2	START BRACKET WELDED	CS	SS4
1	S-ST-W-L-125x60x5	7553301	7533301
2	S-ST-W-L-200x60x5	7553302	7533302
3	S-ST-W-L-300x60x5	7553303	7533303
4	S-ST-W-B-250x60x5	7553304	7533304
5	S-ST-W-L-150x105x5	7553305	7533305
6	S-ST-W-L-200x105x5	7553306	7533306
7	S-ST-W-L-300x105x5	7553307	7533307

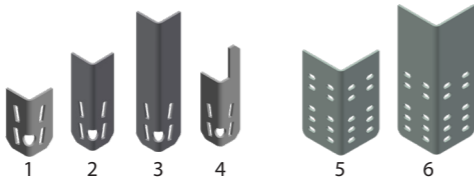

3	START BRACKET WELDED	CS	SS4
1	S-ST-W-U-150x93x4	7553318	7533318
2	S-ST-W-SQS-200-200-5	7553317	7533317
3	S-ST-W-U-240x105x5	7553308	7533308
4	S-ST-W-SQS-150-150-5	7553319	7533319

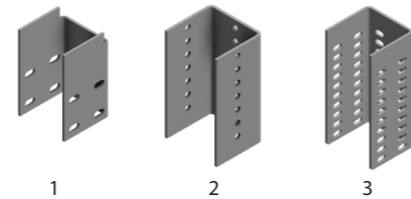

4	START BRACKET BOLTED	HDG	SS4
1	S-ST-B-Z-160x108x4	7513122	7533122
2	S-ST-B-L-125x60x3	7513128	7533128
3	S-ST-B-L-125x60x5	7513106	7533106
4	S-ST-B-L-200x105x3	7513129	7533129
5	S-ST-B-L-200x105x5	7513111	7533111

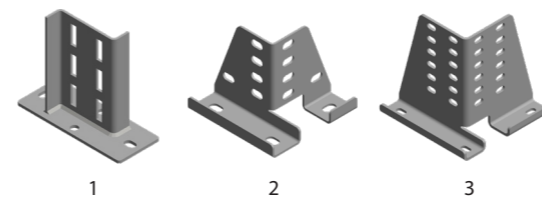

5	CHANNEL	HDG	SS4
1	S-CH-L-50x50x1,5-L30	75118290	75318290
2	S-CH-C-50x25x1,5-L30	75118287	75318226
3	S-CH-C-50x25x2-L30	75118119	75318119
4	S-CH-C-100x25x1,5-L30	75118228	75318228
5	S-CH-C-100x25x2-L30	75118227	75318227

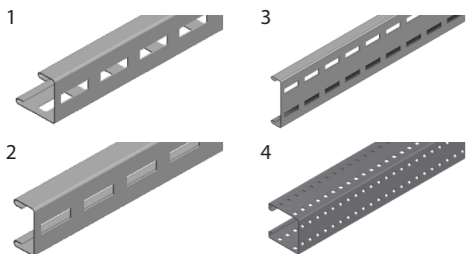

6	CHANNEL	HDG	SS4
1	S-CH-T-50x50x1,5-L30	75118162	75318162
2	S-CH-T-50x50x2-L30	75118163	75318163
3	S-CH-T-50x50x2,5-L30	75118164	75318164
4	S-CH-T-100x100x2-L30	75118160	75318160
5	S-CH-T-100x100x3-L30	75118161	75318161

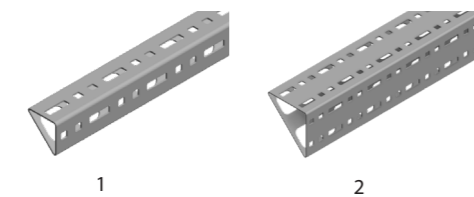

7	CHANNEL	HDG	SS4
1	S-CH-SQS-80x3-L30	75118288	75318288
2	S-CH-SQS-80x4-L30	75118289	75318289
3	S-CH-SQS-100x3-L30	75118281	75318249
4	S-CH-SQS-100x5-L30	75118282	75318250
5	S-CH-SQ-100x100x3-L30	75118165	75318165
6	S-CH-SQ-100x100x5-L30	75118166	75318166

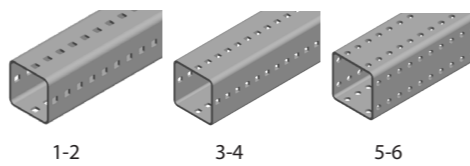

8	START BRACKET BOLTED	HDG	SS4
1	S-ST-B-SQS-150-150-5	7513132	7533132
2	S-ST-B-SQS-200-200-5	7513117	7533117
3	S-ST-B-U-240x105x5	7513113	7533113

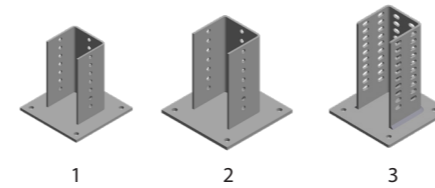

9	CONNECTOR	HDG	SS4
1	S-AB-L-110x110x4-10/10	7513220	7533220
2	S-AB-L-208x208x5-10/10	7513221	7533221
3	S-AB-L-210x195x6-10	7513232	7533232
4	S-SC-T-210x200-6	7511503	7531503

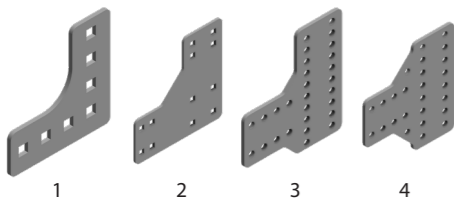

10	BEAM BRACKET	HDG	SS4
1	S-ST-BC-80x80x6	7516601	7536601
2	S-ST-BC-260x50x4	7516603	7536603
3	S-ST-BC-390x50x4	7516604	7536604

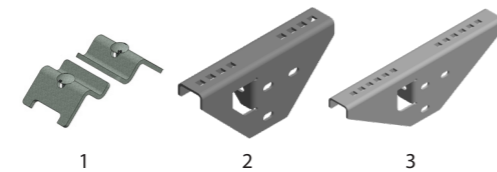

11	BEAM BRACKET	HDG	SS4
1	S-ST-BC-110x110x6	7516602	7536602
2	S-ST-BC-500x110x4	7516605	7536605

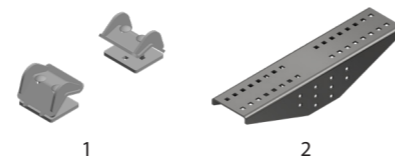

12	CONNECTOR	HDG	SS4
1	S-SC-SQS-200x150-6	7511506	7531506
2	S-ST-B-SQS-U-110x100	7513120	7533120

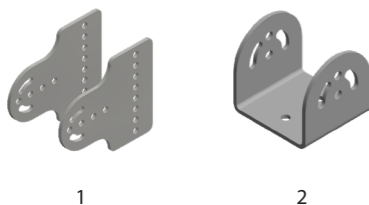

13	FASTENERS	HDG	SS4
1	S-SET-M6x12	7512810	7532801
2	S-SET-H-M10x130	-	7532808
3	S-SET-M10x20	7512808	7532804
4	S-SET-M10x25	7512803	7532805



14	CANTILEVER	HDG	SS4
1	S-CA-30-120	7511901	7531901
2	S-CA-30-160	7511902	7531902
3	S-CA-30-220	7511903	7531903
4	S-CA-30-260	7511904	7531904
5	S-CA-30-320	7511905	7531905
6	S-CA-30-360	7511906	7531906
7	S-CA-30-420	7511907	7531907
8	S-CA-30-460	7511908	7531908

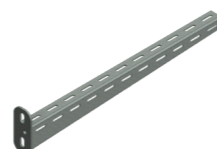

15	CANTILEVER	HDG	SS4
1	S-CA-LT-35-120	7511934	7531934
2	S-CA-LT-35-160	7511935	7531935
3	S-CA-LT-35-220	7511936	7531936
4	S-CA-LT-35-260	7511937	7531937
5	S-CA-LT-35-320	7511938	7531938
6	S-CA-LT-35-360	7511939	7531939
7	S-CA-LT-35-420	7511940	7531940
8	S-CA-LT-35-460	7511941	7531941

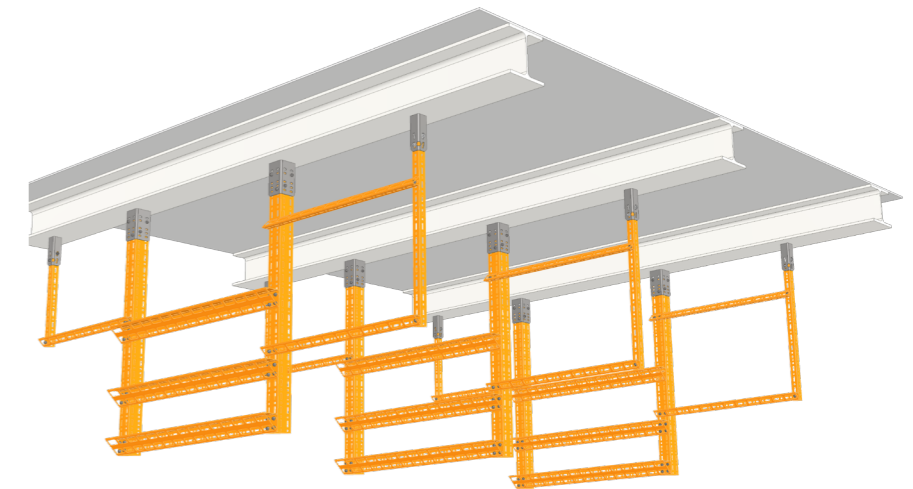
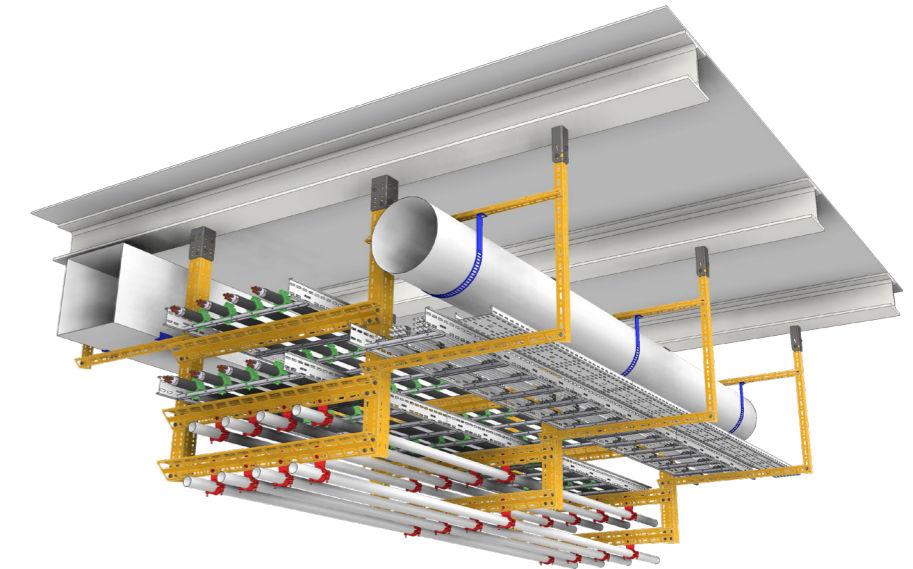
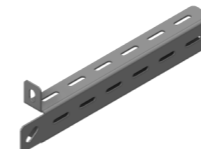

Designation structure							
series	type	item type	height, mm	width, mm	thickness, mm	length, dm	material
S	CH	T	100	100	3	30	SS4
S	ST-W	L	200	105	5		CS
Title							
CHANNEL S-CH-T-100x100x3-L30-SS4							
START BRACKET WELDED S-ST-W-L-200x105x5-CS							

Accepted symbols:

CS - carbon steel
 HDG - hot-dip galvanized steel
 SS4 - stainless steel, resistance class D*

* - corrosion resistance classification according to GOST R 52868-2021



Support system HDG/SS4

1	MOUNTING ITEM	HDG	SS4
1	S-AC-TR-M8x30	-	7533503
2	S-BC-42x33x8-M6	7516606	7536606
3	S-BC-42x33x8-M10	7516607	7536607
4	SDW-B-Ø13-100x65	7818809	7838809
5	S-ST-B-V-100x80x50x3	7513127	7533127

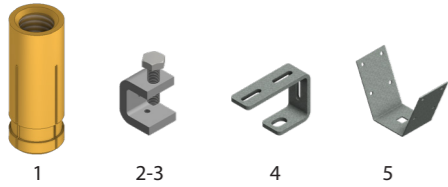

2	START BRACKET BOLTED	HDG	SS4
1	S-ST-B-Z-160x108x4	7513122	7533122
2	S-ST-B-UN-160x130x43	7513121	7533123
3	S-ST-B-UN-160x130x83	7513114	7533124

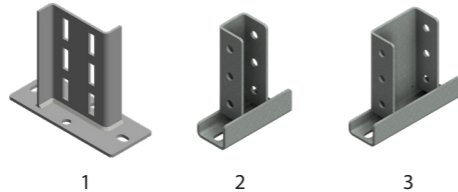

3	START BRACKET BOLTED	HDG	SS4
1	S-ST-B-SQS-150-150-5	7513132	7533132
2	S-ST-B-SQS-200-200-5	7513117	7533117
3	S-ST-B-U-240x105x5	7513113	7533113

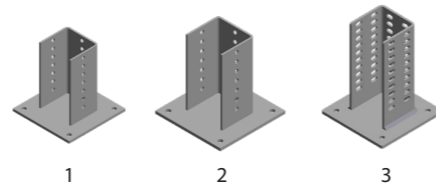

4	CANTILEVER	HDG	SS4
1	S-CA-LT-30-120	7511917	7531917
2	S-CA-LT-30-160	7511918	7531918
3	S-CA-LT-30-220	7511919	7531919
4	S-CA-LT-30-260	7511920	7531920
5	S-CA-LT-30-320	7511921	7531921
6	S-CA-LT-30-360	7511922	7531922
7	S-CA-LT-30-420	7511923	7531923



5	CHANNEL	HDG	SS4
1	S-CH-L-50x50x1,5-L30	75118290	75318290
2	S-CH-C-50x25x1,5-11x30-L30	75118287	75318226
3	S-CH-C-50x25x2-11x30-L30	75118119	75318119
4	S-CH-C-100x25x1,5-11x35-L30	75118228	75318228
5	S-CH-C-100x25x2-11x35-L30	75118227	75318227

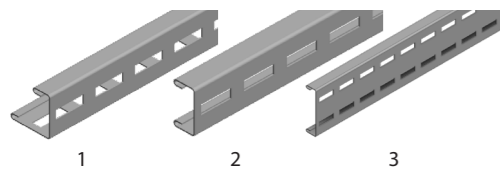

6	CHANNEL	HDG	SS4
1	S-CH-Z-40x40x2-11x30-7x20-L30	75118283	75318251
2	S-CH-Z-50x50x2-11x30-L30	75118286	75318257
3	S-CH-Z-50x50x2,5-11x30-L30	75118120	75318120

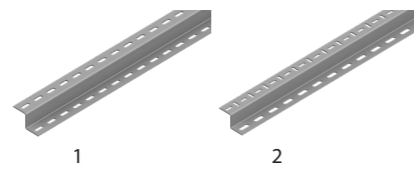

7	CHANNEL	HDG	SS4
1	S-CH-C-60x45x3-11x30-L30	7511829	7531829
2	S-CH-C-60x45x4-11x30-L30	7511858	7531858
3	S-CH-C-70x45x3-11x30-L30	7511887	7531887
4	S-CH-C-70x45x4-11x30-L30	75118116	75318116

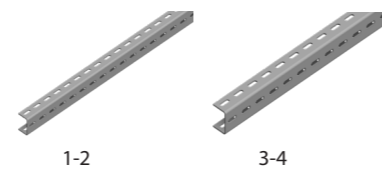

8	CHANNEL	HDG	SS4
1	S-CH-UN-41x21x2-L30	75118279	75318254
2	S-CH-UN-41x21x2,5-L30	75118225	75318230
3	S-CH-UN-41x41x2-L30	-	75318253
4	S-CH-UN-41x41x2,5-L30	75118149	75318149
5	S-CH-UN2-41x43x2,5-L30	75118285	75318256
6	S-CH-UN2-41x83x2,5-L30	75118274	75318255
7	S-CH-UN3-41x41x2,5-L30	75118196	75318198

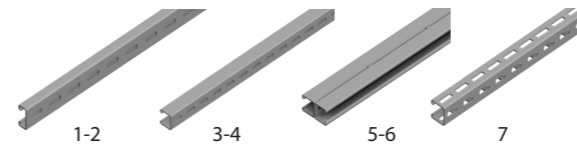

9	CHANNEL	HDG	SS4
1	S-CH-SQS-80x3-L30	75118288	75318288
2	S-CH-SQS-80x4-L30	75118289	75318289
3	S-CH-SQS-100x3-L30	75118281	75318249
4	S-CH-SQS-100x5-L30	75118282	75318250
5	S-CH-SQ-100x100x3-L30	75118165	75318165
6	S-CH-SQ-100x100x5-L30	75118166	75318166

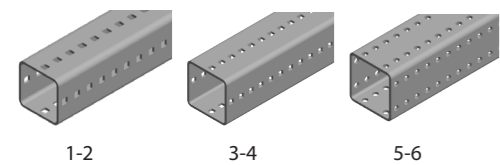

10	CONNECTOR	HDG	SS4
1	S-AB-L-110x110x4-10/10	7513220	7533220
2	S-AB-L-208x208x5-10/10	7513221	7533221
3	S-AB-L-210x195x6-10	7513232	7533232
4	S-SC-T-210x200-6	7511503	7531503
5	S-SC-SQS-200x150-6	7511506	7531506
6	S-ST-B-SQS-U-110x100	7513120	7533120

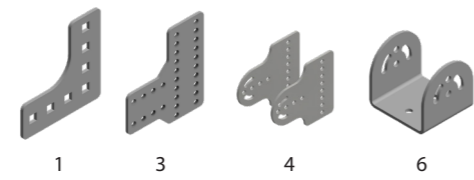

11	CONNECTOR	HDG	SS4
1	S-AB-UN-L-52x52x4	7513228	7533228
2	S-AB-UN-L-90x50x5	7513260	7533260
3	S-AB-UN-L-107x39x5	7513243	7533243
4	S-AB-UN-L-135x50x5	7513261	7533261
5	S-AB-UN-L-105x88x5	7513240	7533240

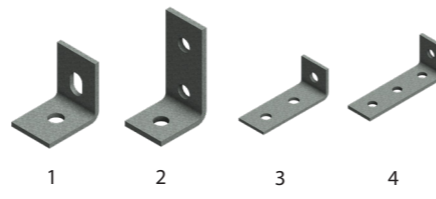

12	CONNECTOR	HDG	SS4
1	S-AB-UN-I-45x40x6-9	7513250	7533250
2	S-AB-UN-I-45x40x6-13	7513245	7533245
3	S-AB-UN-I-90x40x6-13	7513246	7533246
4	S-AB-UN-I-135x40x6-13	7513247	7533247
5	S-AB-UN-I-180x40x6-13	7513248	7533248
6	S-AB-UN-I-225x40x6-13	7513249	7533249

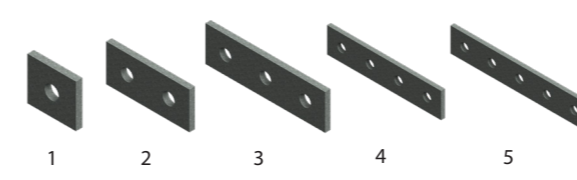

13	CONNECTOR	HDG	SS4
1	S-AB-UN-T-135x90x5	7513257	7533257
2	S-AB-UN-T-136x90x5	7513258	7533258
3	S-AB-UN-L-90x90x5	7513256	7533256
4	S-AB-UN-X-135x90x5	7513259	7533259

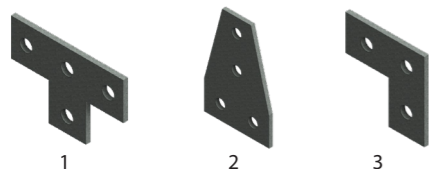

14	CONNECTOR	HDG	SS4
1	S-AB-UN-U-130x21x5	7513253	7533253
2	S-AB-UN-U-130x43x5	7513254	7533254
3	S-AB-UN-U-130x83x5	7513255	7533255



15	CANTILEVER	HDG	SS4
1	S-CA-LT-35-120	7511934	7531934
2	S-CA-LT-35-160	7511935	7531935
3	S-CA-LT-35-220	7511936	7531936
4	S-CA-LT-35-260	7511937	7531937
5	S-CA-LT-35-320	7511938	7531938
6	S-CA-LT-35-360	7511939	7531939
7	S-CA-LT-35-420	7511940	7531940
8	S-CA-LT-35-460	7511941	7531941

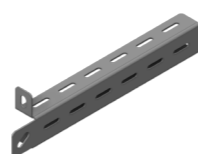

16	CANTILEVER	HDG	SS4
1	S-CA-30-120	7511901	7531901
2	S-CA-30-160	7511902	7531902
3	S-CA-30-220	7511903	7531903
4	S-CA-30-260	7511904	7531904
5	S-CA-30-320	7511905	7531905
6	S-CA-30-360	7511906	7531906
7	S-CA-30-420	7511907	7531907
8	S-CA-30-460	7511908	7531908

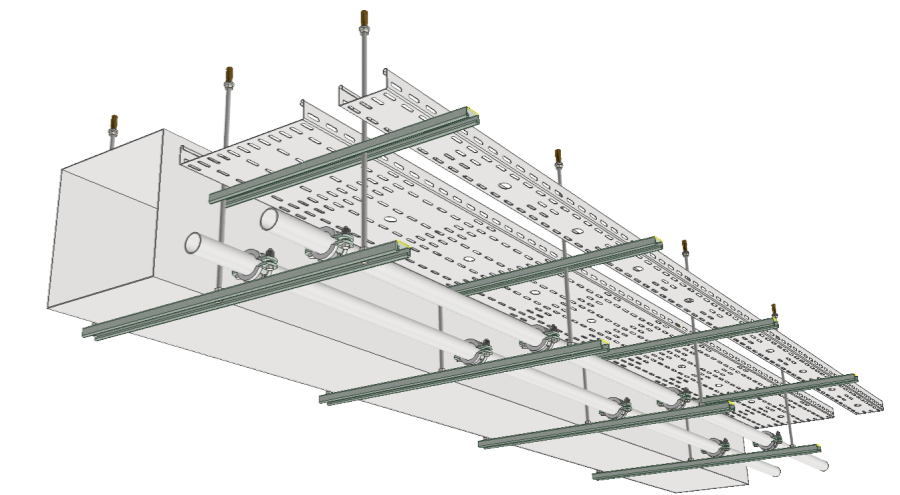

Designation structure							
series	type	item type	height, mm	width, mm	thickness, mm	length, dm	material
S	CH	UN	41	41	2,5	3000 (L30)	HDG
S	ST-B	UN	160	130	-	43	SS4
Title							
CHANNEL S-CH-UN-41x41x2,5-L30-HDG							
Start bracket bolted S-ST-B-UN-160x130x43-SS4							



Accepted symbols:

PG - pre-galvanized steel

HDG - hot-dip galvanized steel

SS4 - stainless steel, resistance class D*

* - corrosion resistance classification according to GOST R 52868-2021

17	FASTENERS	HDG	SS4
1	S-SET-M6x12	7512810	7532801
2	S-SET-M10x20	7512808	7532804
3	S-SET-M10x25	7512803	7532805
4	S-SET-H-M10x130	-	7532808
5	S-HEX-M10x30	7512908	7532908
6	S-NU-FL-M10	7515307	7535311
7	S-NU-HE-M10	7515407	7535411
8	S-TR-M10x1000	7513402	7533407
9	S-NU-U-M10-21	7518203	7538203
10	S-NU-U-M10-41	7518207	7538207

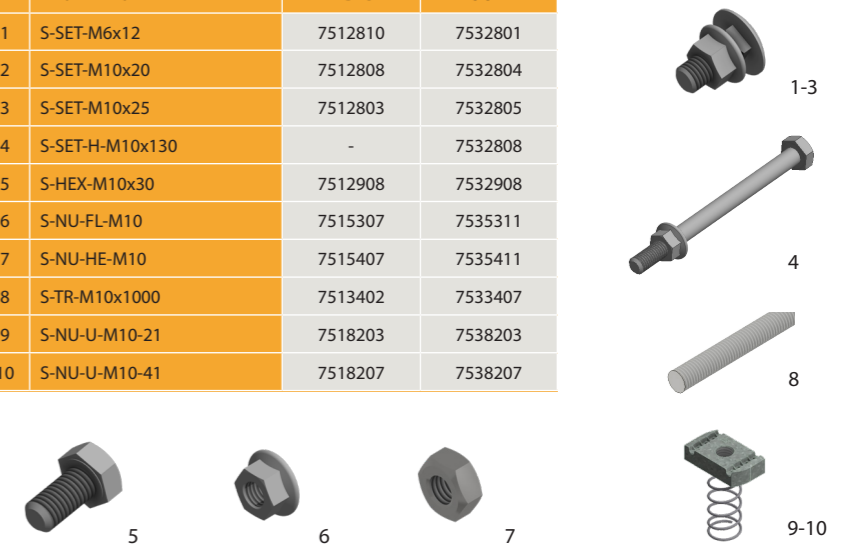

Cable tray system TMD-40 1,0mm R=75 PG/ HDG



1 CABLE TRAY TMD-40-CT		
Width	PG	HDG
50	7340740	7310740
100	7340741	7310741
150	7340742	7310742
200	7340743	7310743
300	7340744	7310744
400	7340745	7310745
500	7340746	7310746
600	7340747	7310747

2 FLAT ELBOW 90° TMD-40-FE-90		
Width	PG	HDG
50	7340879	7310879
100	7340880	7310880
150	7340881	7310881
200	7340882	7310882
300	7340883	7310883
400	7340884	7310884
500	7340885	7310885
600	7340886	7310886

3 FLAT ELBOW 45° TMD-40-FE-45		
Width	PG	HDG
50	7341079	7311079
100	7341080	7311080
150	7341081	7311081
200	7341082	7311082
300	7341083	7311083
400	7341084	7311084
500	7341085	7311085
600	7341086	7311086

4 FLAT ELBOW 30° TMD-40-FE-30		
Width	PG	HDG
50	7341179	7311179
100	7341180	7311180
150	7341181	7311181
200	7341182	7311182
300	7341183	7311183
400	7341184	7311184
500	7341185	7311185
600	7341186	7311186

5 ELBOW FLEXI 0-90° TMD-40-EF		
Width	PG	HDG
50	7346379	7316379
100	7346380	7316380
150	7346381	7316381
200	7346382	7316382
300	7346383	7316383
400	7346384	7316384
500	7346385	7316385
600	7346386	7316386

6 FLEXI RISER TMD-40-FR		
Width	PG	HDG
50	73412162	73112162
100	73412163	73112163
150	73412164	73112164
200	73412165	73112165
300	73412166	73112166
400	73412167	73112167
500	73412168	73112168
600	73412169	73112169

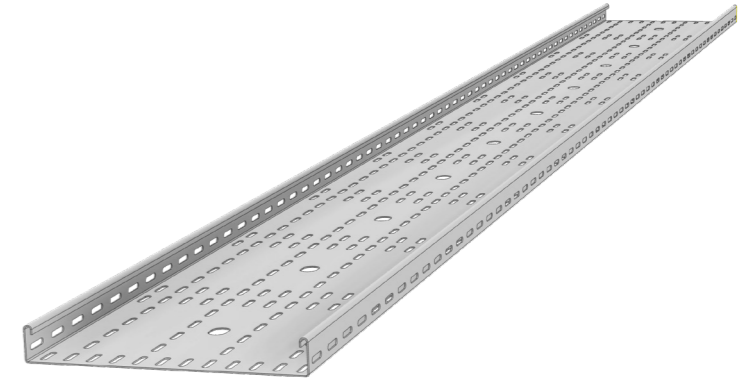

7 COVER TMD-CO		
Width	PG	HDG
50	7342109	7312109
100	7342111	7312111
150	7342112	7312112
200	7342113	7312113
300	7342114	7312114
400	7342115	7312115
500	7342116	7312116
600	7342117	7312117

8 COVER 90° TMD-CO-90		
Width	PG	HDG
50	7342217	7312217
100	7342219	7312219
150	7342220	7312220
200	7342221	7312221
300	7342222	7312222
400	7342223	7312223
500	7342231	7312231
600	7342232	7312232

9 COVER 45° TMD-CO-45		
Width	PG	HDG
50	7343601	7313601
100	7343603	7313603
150	7343604	7313604
200	7343605	7313605
300	7343606	7313606
400	7343607	7313607
500	7343631	7313631
600	7343632	7313632

10 COVER 30° TMD-CO-30		
Width	PG	HDG
50	7346117	7316117
100	7346119	7316119
150	7346120	7316120
200	7346121	7316121
300	7346122	7316122
400	7346123	7316123
500	7346131	7316131
600	7346132	7316132

11 COVER 0-90° TMD-CO-EF		
Width	PG	HDG
50	7346417	7316417
100	7346419	7316419
150	7346420	7316420
200	7346421	7316421
300	7346422	7316422
400	7346423	7316423
500	7346431	7316431
600	7346432	7316432

12 COVER RISER TMD-CO-FR		
Width	PG	HDG
50	7342517	7312517
100	7342519	7312519
150	7342520	7312520
200	7342521	7312521
300	7342522	7312522
400	7342523	7312523
500	7342531	7312531
600	7342532	7312532

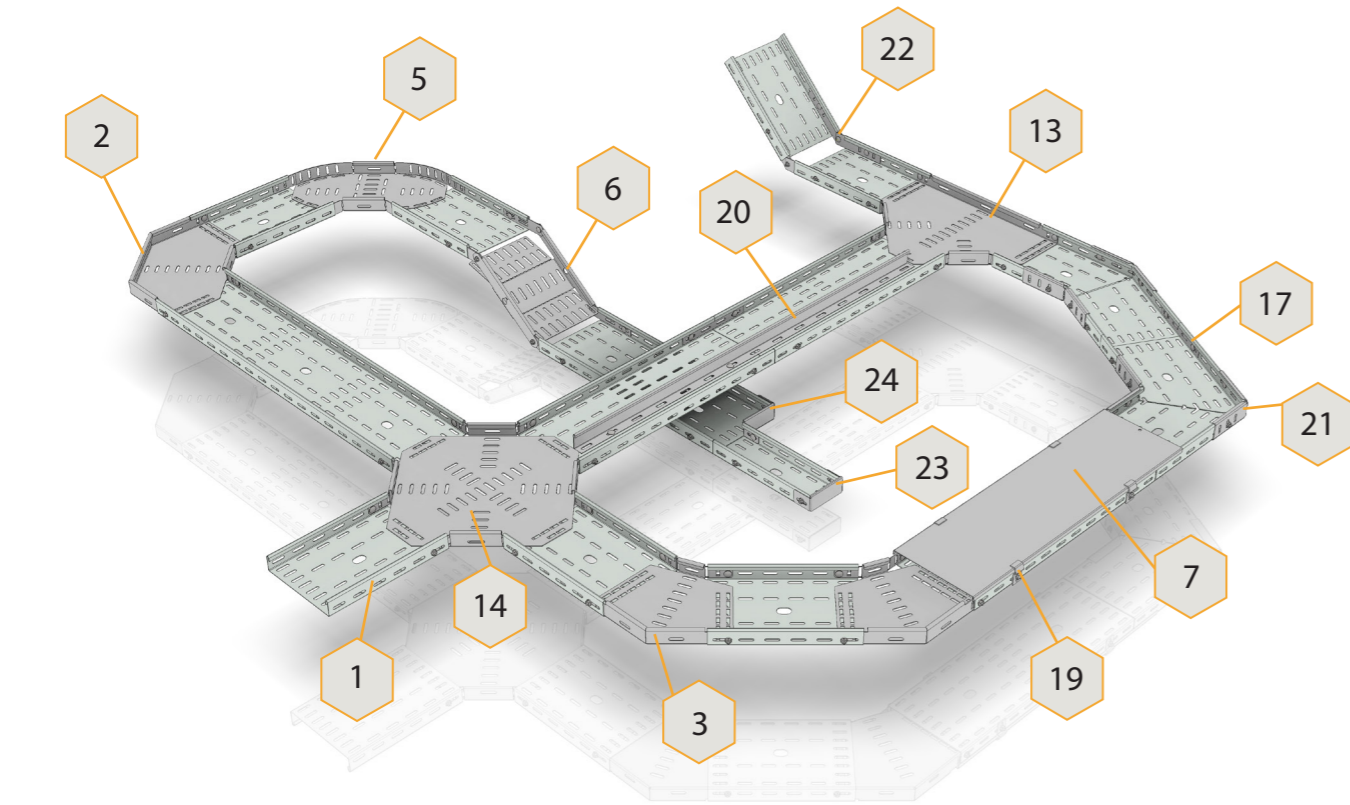

13 T-PIECE TMD-40-TE		
Width	PG	HDG
50	7341379	7311379
100	7341380	7311380
150	7341381	7311381
200	7341382	7311382
300	7341383	7311383
400	7341384	7311384
500	7341385	7311385
600	7341386	7311386

14 X-PIECE TMD-40-XE		
Width	PG	HDG
50	7341479	7311479
100	7341480	7311480
150	7341481	7311481
200	7341482	7311482
300	7341483	7311483
400	7341484	7311484
500	7341485	7311485
600	7341486	7311486

15 COVER-T TMD-CO-TE		
Width	PG	HDG
50	7342317	7312317
100	7342319	7312319
150	7342320	7312320
200	7342321	7312321
300	7342322	7312322
400	7342323	7312323
500	7342331	7312331
600	7342332	7312332

16 COVER X TMD-CO-XE		
Width	PG	HDG
50	7342417	7312417
100	7342419	7312419
150	7342420	7312420
200	7342421	7312421
300	7342422	7312422
400	7342423	7312423
500	7342431	7312431
600	7342432	7312432

17 SPLICE CONNECTOR TMD-40-SC	
PG	HDG
7341512	7311512

18 CONNECTOR PLATE TMD-SC-PL	
PG	HDG
7341511	7311511

19 COVER CLAMP TMD-CO-FC		
Type	PG	HDG
FC	7342601	7312601
FC-V	7342605	7312605

20 DIVIDER TMD-40-DI		
Type	PG	HDG
DI	7343701	7313701
DI-FR	7346201	7316201
DI-FE	7343801	7313801

21 HINGE HORIZONTAL TMD-40-HI-G	
PG	HDG
7341601	7311601

22 HINGE VERTICAL TMD-40-HI-V	
PG	HDG
7341701	7311701

Designation structure							
series	height, mm	type	width, mm	thickness, mm	length, m	radius	material
TMD	40	CT	100	1,0	3	-	HDG
TMD	40	FE-90	300	1,0	-	R75	PG
Title							
Cable tray TMD - 40 - CT - 100 - 1,0 - 3 - HDG							
FLAT ELBOW 90° TMD - 40 - FE - 90 - 300 - 1,0 - R75 - PG							

Accepted symbols:
 low cable loads
 PG - pre-galvanized steel
 HDG - hot-dip galvanized steel
 Cable tray thickness: 1,0 mm
 Cover thickness: 1,0 mm;



23 END CAP TMD-40-EC		
Width	PG	HDG
50	7344901	7314901
100	7344902	7314902
150	7344903	7314903
200	7344904	7314904
300	7344905	7314905
400	7344906	7314906
500	7344907	7314907
600	7344908	7314908

24 REDUCER TMD-40-RP		
Width	PG	HDG
50	7343901	7313901
100	7343902	7313902
150	7343903	7313903
200	7343904	7313904
250	7343905	7313905
300	7343906	7313906
400	7343907	7313907

Cable tray system TMD-40 R=75 PG/ HDG



1 CABLE TRAY TMD-40-CT			2 FLAT ELBOW 90° TMD-40-FE-90			3 FLAT ELBOW 45° TMD-40-FE-45			4 FLAT ELBOW 30° TMD-40-FE-30			5 ELBOW FLEXI 0-90° TMD-40-EF			6 FLEXI RISER TMD-40-FR		
Width	PG	HDG	Width	PG	HDG	Width	PG	HDG	Width	PG	HDG	Width	PG	HDG	Width	PG	HDG
50	7340701	7310701	50	7340801	7310801	50	7341001	7311001	50	7341101	7311101	50	7346301	7316301	50	7341201	7311201
100	7340702	7310702	100	7340802	7310802	100	7341002	7311002	100	7341102	7311102	100	7346302	7316302	100	7341202	7311202
150	7340703	7310703	150	7340803	7310803	150	7341003	7311003	150	7341103	7311103	150	7346303	7316303	150	7341203	7311203
200	7340704	7310704	200	7340804	7310804	200	7341004	7311004	200	7341104	7311104	200	7346304	7316304	200	7341204	7311204
300	7340705	7310705	300	7340805	7310805	300	7341005	7311005	300	7341105	7311105	300	7346305	7316305	300	7341205	7311205
400	7340706	7310706	400	7340806	7310806	400	7341006	7311006	400	7341106	7311106	400	7346306	7316306	400	7341206	7311206
500	7340707	7310707	500	7340807	7310807	500	7341007	7311007	500	7341107	7311107	500	7346307	7316307	500	7341207	7311207
600	7340708	7310708	600	7340808	7310808	600	7341008	7311008	600	7341108	7311108	600	7346308	7316308	600	7341208	7311208

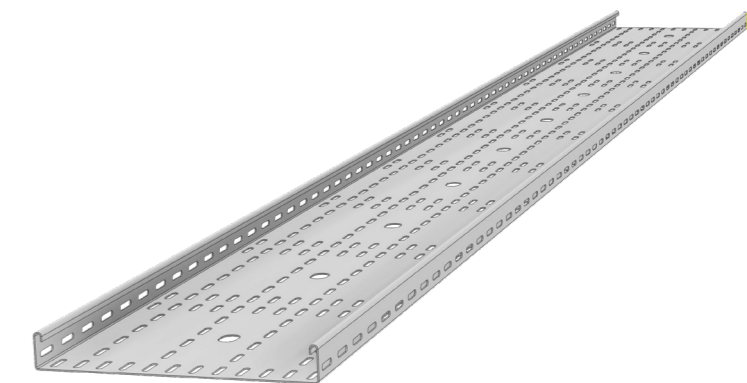

7 COVER TMD-CO			8 COVER 90° TMD-CO-90			9 COVER 45° TMD-CO-45			10 COVER 30° TMD-CO-30			11 COVER 0-90° TMD-CO-EF			12 COVER RISER TMD-CO-FR		
Width	PG	HDG	Width	PG	HDG	Width	PG	HDG	Width	PG	HDG	Width	PG	HDG	Width	PG	HDG
50	7342109	7312109	50	7342217	7312217	50	7343601	7313601	50	7346117	7316117	50	7346417	7316417	50	7342517	7312517
100	7342111	7312111	100	7342219	7312219	100	7343603	7313603	100	7346119	7316119	100	7346419	7316419	100	7342519	7312519
150	7342112	7312112	150	7342220	7312220	150	7343604	7313604	150	7346120	7316120	150	7346420	7316420	150	7342520	7312520
200	7342113	7312113	200	7342221	7312221	200	7343605	7313605	200	7346121	7316121	200	7346421	7316421	200	7342521	7312521
300	7342105	7312105	300	7342205	7312205	300	7343612	7313612	300	7346105	7316105	300	7346405	7316405	300	7342505	7312505
400	7342106	7312106	400	7342206	7312206	400	7343613	7313613	400	7346106	7316106	400	7346406	7316406	400	7342506	7312506
500	7342107	7312107	500	7342207	7312207	500	7343614	7313614	500	7346107	7316107	500	7346407	7316407	500	7342507	7312507
600	7342108	7312108	600	7342208	7312208	600	7343615	7313615	600	7346108	7316108	600	7346408	7316408	600	7342508	7312508

Designation structure							
series	height, mm	element type	width, mm	thickness, mm	length, m	radius	material
TMD	40	CT	100	1,5	3	-	HDG
TMD	40	FE-90	300	1,5	-	R75	PG
Title							
Cable tray TMD - 40 - CT - 100 - 1,5 - 3 - HDG							
FLAT ELBOW 90° TMD - 40 - FE - 90 - 300 - 1,5 - R75 - PG							

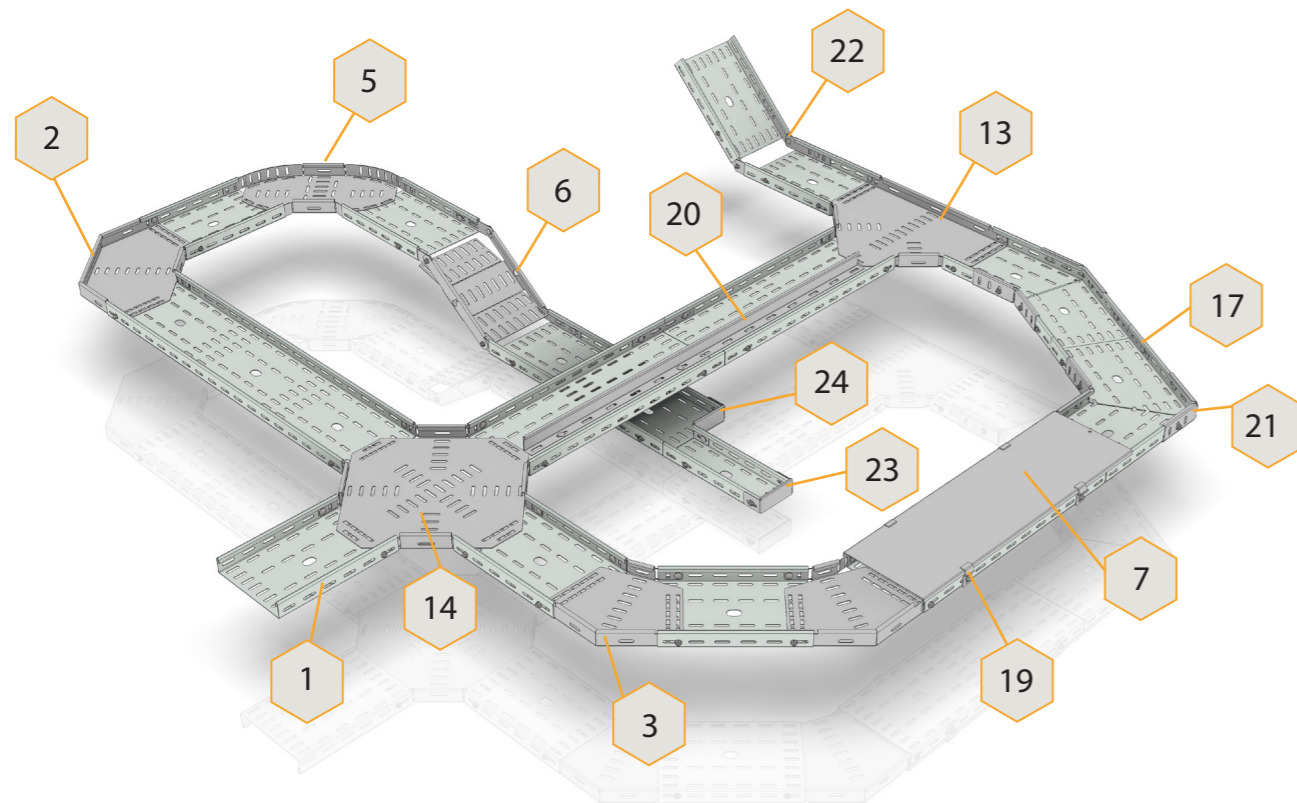

13 T-PIECE TMD-40-TE			14 X-PIECE TMD-40-XE		
Width	PG	HDG	Width	PG	HDG
50	7341301	7311301	50	7341401	7311401
100	7341302	7311302	100	7341402	7311402
150	7341303	7311303	150	7341403	7311403
200	7341304	7311304	200	7341404	7311404
300	7341305	7311305	300	7341405	7311405
400	7341306	7311306	400	7341406	7311406
500	7341307	7311307	500	7341407	7311407
600	7341308	7311308	600	7341408	7311408

Accepted symbols:
 average cable loads
 PG - pre-galvanized steel
 HDG - hot-dip galvanized steel
 Thickness of cable trays: 1,5 mm
 Cover thickness: from 50 to 200 - 1, mm; from 300 to 600 - 1,5 mm



15 COVER T TMD-CO-TE			16 COVER X TMD-CO-XE		
Width	PG	HDG	Width	PG	HDG
50	7342317	7312317	50	7342417	7312417
100	7342319	7312319	100	7342419	7312419
150	7342320	7312320	150	7342420	7312420
200	7342321	7312321	200	7342421	7312421
300	7342305	7312305	300	7342405	7312405
400	7342306	7312306	400	7342406	7312406
500	7342307	7312307	500	7342407	7312407
600	7342308	7312308	600	7342408	7312408

23 END CAP TMD-40-EC		
Width	PG	HDG
50	7344901	7314901
100	7344902	7314902
150	7344903	7314903
200	7344904	7314904
300	7344905	7314905
400	7344906	7314906
500	7344907	7314907
600	7344908	7314908

24 REDUCER TMD-40-RP		
Width	PG	HDG
50	7343901	7313901
100	7343902	7313902
150	7343903	7313903
200	7343904	7313904
250	7343905	7313905
300	7343906	7313906
400	7343907	7313907

17 SPLICE CONNECTOR TMD-40-SC	
PG	HDG
7341501	7311501

18 CONNECTOR PLATE TMD-SC-PL	
PG	HDG
7341511	7311511

19 COVER CLAMP TMD-CO-FC		
Type	PG	HDG
FC	7342601	7312601
FC-V	7342605	7312605

20 DIVIDER TMD-40-DI		
Type	PG	HDG
DI	7343701	7313701
DI-FR	7346201	7316201
DI-FE	7343801	7313801

21 HINGE HORIZONTAL TMD-40-HI-G	
PG	HDG
7341601	7311601

22 HINGE VERTICAL TMD-40-HI-V	
PG	HDG
7341701	7311701

Cable tray system TMD-40 R=75 SS2/SS4

1 CABLE TRAY TMD-40-CT		
Width	SS2	SS4
50	7320701	7330701
100	7320702	7330702
150	7320703	7330703
200	7320704	7330704
300	7320705	7330705
400	7320706	7330706
500	7320707	7330707
600	7320708	7330708

2 FLAT ELBOW 90° TMD-40-FE-90		
Width	SS2	SS4
50	7320801	7330801
100	7320802	7330802
150	7320803	7330803
200	7320804	7330804
300	7320805	7330805
400	7320806	7330806
500	7320807	7330807
600	7320808	7330808

3 FLAT ELBOW 45° TMD-40-FE-45		
Width	SS2	SS4
50	7321001	7331001
100	7321002	7331002
150	7321003	7331003
200	7321004	7331004
300	7321005	7331005
400	7321006	7331006
500	7321007	7331007
600	7321008	7331008

4 FLAT ELBOW 30° TMD-40-FE-30		
Width	SS2	SS4
50	7321101	7331101
100	7321102	7331102
150	7321103	7331103
200	7321104	7331104
300	7321105	7331105
400	7321106	7331106
500	7321107	7331107
600	7321108	7331108

5 ELBOW FLEXI 0-90° TMD-40-EF		
Width	SS2	SS4
50	7326301	7336301
100	7326302	7336302
150	7326303	7336303
200	7326304	7336304
300	7326305	7336305
400	7326306	7336306
500	7326307	7336307
600	7326308	7336308

6 FLEXI RISER TMD-40-FR		
Width	SS2	SS4
50	7321201	7331201
100	7321202	7331202
150	7321203	7331203
200	7321204	7331204
300	7321205	7331205
400	7321206	7331206
500	7321207	7331207
600	7321208	7331208

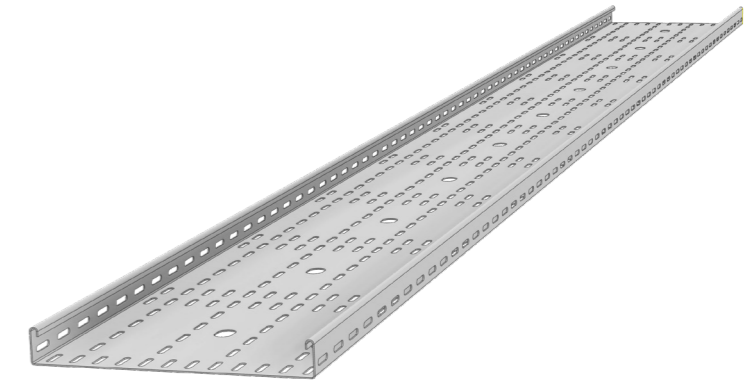

7 COVER TMD-CO		
Width	SS2	SS4
50	7322109	7332109
100	7322111	7332111
150	7322112	7332112
200	7322113	7332113
300	7322105	7332105
400	7322106	7332106
500	7322107	7332107
600	7322108	7332108

8 COVER 90° TMD-CO-90		
Width	SS2	SS4
50	7322217	7332217
100	7322219	7332219
150	7322220	7332220
200	7322221	7332221
300	7322205	7332205
400	7322206	7332206
500	7322207	7332207
600	7322208	7332208

9 COVER 45° TMD-CO-45		
Width	SS2	SS4
50	7323601	7333601
100	7323603	7333603
150	7323604	7333604
200	7323605	7333605
300	7323612	7333612
400	7323613	7333613
500	7323614	7333614
600	7323615	7333615

10 COVER 30° TMD-CO-30		
Width	SS2	SS4
50	7326117	7336117
100	7326119	7336119
150	7326120	7336120
200	7326121	7336121
300	7326105	7336105
400	7326106	7336106
500	7326107	7336107
600	7326108	7336108

11 COVER 0-90° TMD-CO-EF		
Width	SS2	SS4
50	7326417	7336417
100	7326419	7336419
150	7326420	7336420
200	7326421	7336421
300	7326405	7336405
400	7326406	7336406
500	7326407	7336407
600	7326408	7336408

12 COVER RISER TMD-CO-FR		
Width	SS2	SS4
50	7322517	7332517
100	7322519	7332519
150	7322520	7332520
200	7322521	7332521
300	7322505	7332505
400	7322506	7332506
500	7322507	7332507
600	7322508	7332508

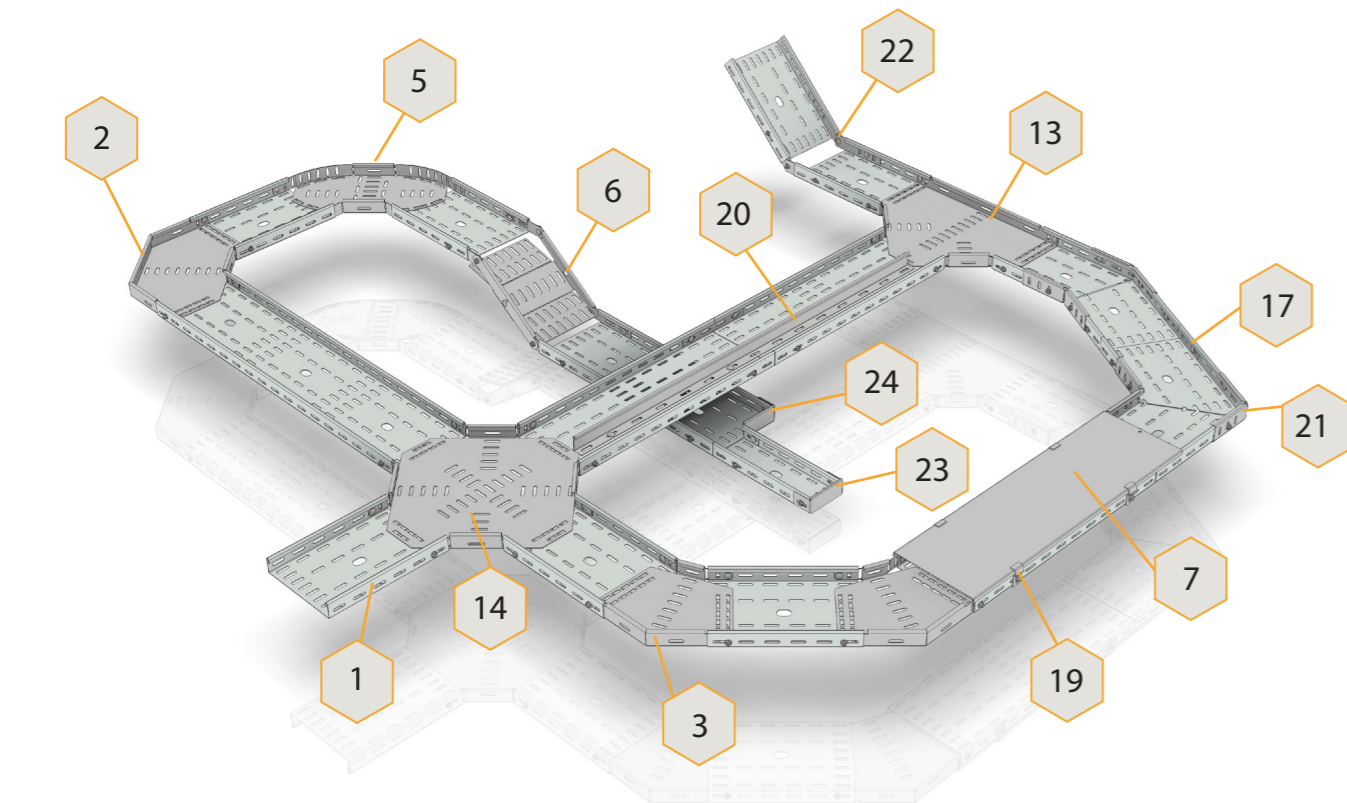

13 T-PIECE TMD-40-TE		
Width	SS2	SS4
50	7321301	7331301
100	7321302	7331302
150	7321303	7331303
200	7321304	7331304
300	7321305	7331305
400	7321306	7331306
500	7321307	7331307
600	7321308	7331308

14 X-PIECE TMD-40-XE		
Width	SS2	SS4
50	7321401	7331401
100	7321402	7331402
150	7321403	7331403
200	7321404	7331404
300	7321405	7331405
400	7321406	7331406
500	7321407	7331407
600	7321408	7331408

15 COVER T TMD-CO-TE		
Width	SS2	SS4
50	7322317	7332317
100	7322319	7332319
150	7322320	7332320
200	7322321	7332321
300	7322305	7332305
400	7322306	7332306
500	7322307	7332307
600	7322308	7332308

16 COVER X TMD-CO-XE		
Width	SS2	SS4
50	7322417	7332417
100	7322419	7332419
150	7322420	7332420
200	7322421	7332421
300	7322405	7332405
400	7322406	7332406
500	7322407	7332407
600	7322408	7332408

17 SPLICE CONNECTOR TMD-40-SC		
Type	SS2	SS4
SS2	7321501	7331501
SS4	7331501	

18 CONNECTOR PLATE TMD-SC-PL		
Type	SS2	SS4
SS2	7321511	7331511
SS4	7331511	

19 COVER CLAMP TMD-CO-FC		
Type	SS2	SS4
FC	7322601	7332601
FC-V	7322605	7332605

20 DIVIDER TMD-40-DI		
Type	SS2	SS4
DI	7343701	7313701
DI-FR	7346201	7316201
DI-FE	7343801	7313801

21 HINGE HORIZONTAL TMD-40-HI-G		
Type	SS2	SS4
SS2	7321601	7331601
SS4	7331601	

22 HINGE VERTICAL TMD-40-HI-V		
Type	SS2	SS4
SS2	7321701	7331701
SS4	7331701	

Designation structure							
series	height, mm	element type	width, mm	thickness, mm	length, m	radius	material
TMD	40	CT	100	1,5	3	-	SS4
TMD	40	FE-90	300	1,5	-	R75	SS2
Title							
Cable tray TMD - 40 - CT - 100 - 1,5 - 3 - SS4							
FLAT ELBOW 90° TMD - 40 - FE - 90 - 300 - 1,5 - R75 - SS2							

Accepted symbols:

average cable loads

SS2 - stainless steel, resistance class A*

SS4 - stainless steel, resistance class D*

Thickness of cable trays: 1,5 mm

Cover thickness: from 50 to 200 - 1.0 mm; from 300 to 600 - 1.5 mm

* - corrosion resistance classification according to GOST R 52868-2021



23 END CAP TMD-40-EC		
Width	SS2	SS4
50	7324901	7334901
100	7324902	7334902
150	7324903	7334903
200	7324904	7334904
300	7324905	7334905
400	7324906	7334906
500	7324907	7334907
600	7324908	7334908

24 REDUCER TMD-40-RP		
Width	SS2	SS4
50	7323901	7333901
100	7323902	7333902
150	7323903	7333903
200	7323904	7333904
250	7323905	7333905
300	7323906	7333906
400	7323907	7333907

Cable tray system TMD-50 R=75 PG/ HDG



1 CABLE TRAY TMD-50-CT			2 FLAT ELBOW 90° TMD-50-FE-90			3 FLAT ELBOW 45° TMD-50-FE-45			4 FLAT ELBOW 30° TMD-50-FE-30			5 ELBOW FLEXI 0-90° TMD-50-EF			6 FLEXI RISER TMD-50-FR		
Width	PG	HDG	Width	PG	HDG	Width	PG	HDG	Width	PG	HDG	Width	PG	HDG	Width	PG	HDG
50	7340709	7310709	50	7340809	7310809	50	7341009	7311009	50	7341109	7311109	50	7346309	7316309	50	7341209	7311209
100	7340710	7310710	100	7340810	7310810	100	7341010	7311010	100	7341110	7311110	100	7346310	7316310	100	7341210	7311210
150	7340711	7310711	150	7340811	7310811	150	7341011	7311011	150	7341111	7311111	150	7346311	7316311	150	7341211	7311211
200	7340712	7310712	200	7340812	7310812	200	7341012	7311012	200	7341112	7311112	200	7346312	7316312	200	7341212	7311212
300	7340713	7310713	300	7340813	7310813	300	7341013	7311013	300	7341113	7311113	300	7346313	7316313	300	7341213	7311213
400	7340714	7310714	400	7340814	7310814	400	7341014	7311014	400	7341114	7311114	400	7346314	7316314	400	7341214	7311214
500	7340715	7310715	500	7340815	7310815	500	7341015	7311015	500	7341115	7311115	500	7346315	7316315	500	7341215	7311215
600	7340716	7310716	600	7340816	7310816	600	7341016	7311016	600	7341116	7311116	600	7346316	7316316	600	7341216	7311216

7 COVER TMD-CO			8 COVER 90° TMD-CO-90			9 COVER 45° TMD-CO-45			10 COVER 30° TMD-CO-30			11 COVER 0-90° TMD-CO-EF			12 COVER RISER TMD-CO-FR		
Width	PG	HDG	Width	PG	HDG	Width	PG	HDG	Width	PG	HDG	Width	PG	HDG	Width	PG	HDG
50	7342109	7312109	50	7342217	7312217	50	7343601	7313601	50	7346117	7316117	50	7346417	7316417	50	7342517	7312517
100	7342111	7312111	100	7342219	7312219	100	7343603	7313603	100	7346119	7316119	100	7346419	7316419	100	7342519	7312519
150	7342112	7312112	150	7342220	7312220	150	7343604	7313604	150	7346120	7316120	150	7346420	7316420	150	7342520	7312520
200	7342113	7312113	200	7342221	7312221	200	7343605	7313605	200	7346121	7316121	200	7346421	7316421	200	7342521	7312521
300	7342105	7312105	300	7342205	7312205	300	7343612	7313612	300	7346105	7316105	300	7346405	7316405	300	7342505	7312505
400	7342106	7312106	400	7342206	7312206	400	7343613	7313613	400	7346106	7316106	400	7346406	7316406	400	7342506	7312506
500	7342107	7312107	500	7342207	7312207	500	7343614	7313614	500	7346107	7316107	500	7346407	7316407	500	7342507	7312507
600	7342108	7312108	600	7342208	7312208	600	7343615	7313615	600	7346108	7316108	600	7346408	7316408	600	7342508	7312508

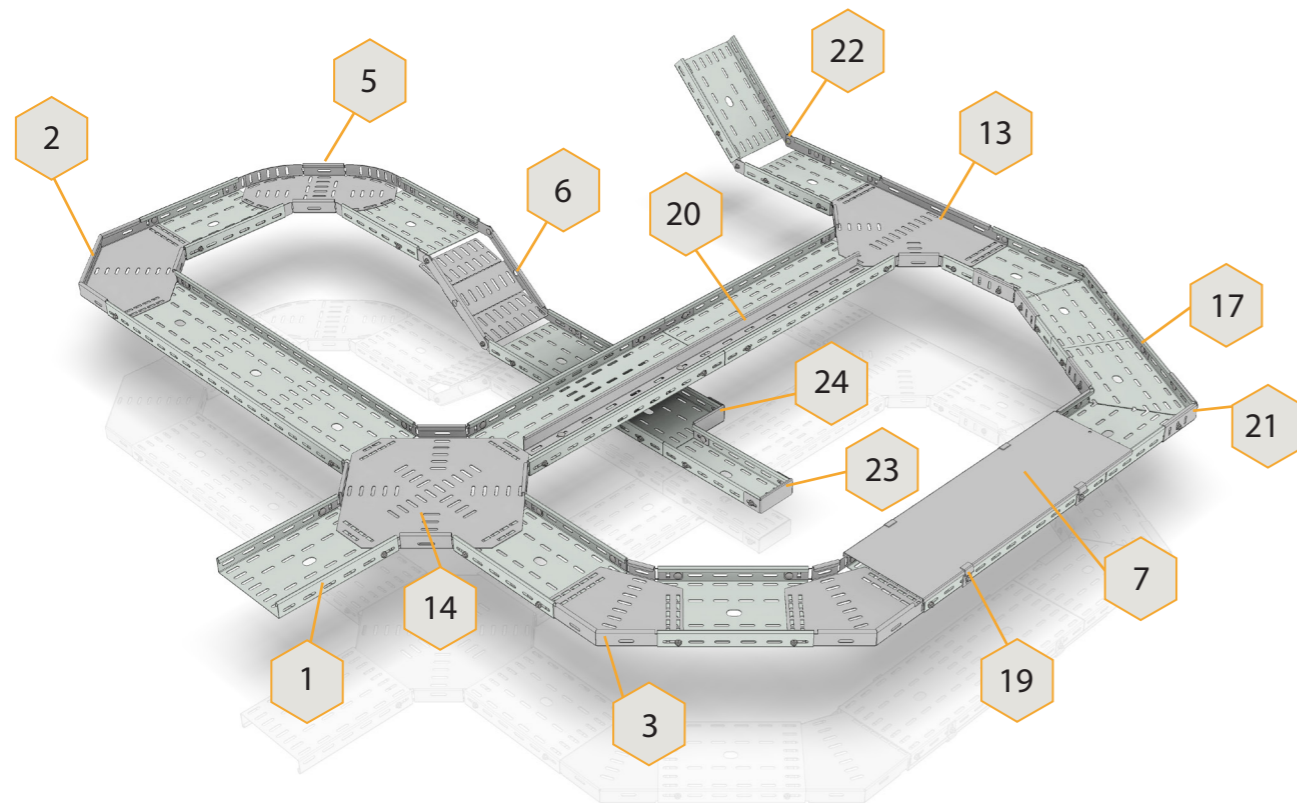
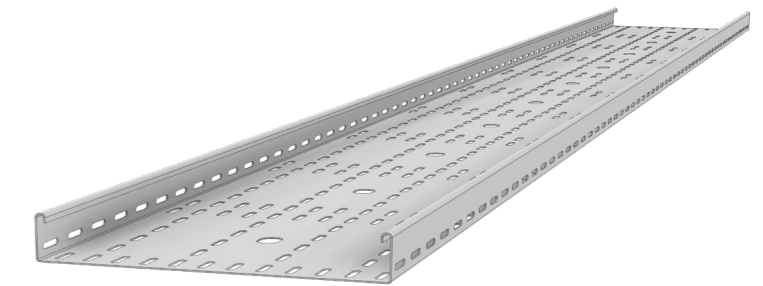

13 T-PIECE TMD-50-TE			14 X-PIECE TMD-50-XE		
Width	PG	HDG	Width	PG	HDG
50	7341309	7311309	50	7341409	7311409
100	7341310	7311310	100	7341410	7311410
150	7341311	7311311	150	7341411	7311411
200	7341312	7311312	200	7341412	7311412
300	7341313	7311313	300	7341413	7311413
400	7341314	7311314	400	7341414	7311414
500	7341315	7311315	500	7341415	7311415
600	7341316	7311316	600	7341416	7311416

15 COVER T TMD-CO-TE			16 COVER X TMD-CO-XE		
Width	PG	HDG	Width	PG	HDG
50	7342317	7312317	50	7342417	7312417
100	7342319	7312319	100	7342419	7312419
150	7342320	7312320	150	7342420	7312420
200	7342321	7312321	200	7342421	7312421
300	7342305	7312305	300	7342405	7312405
400	7342306	7312306	400	7342406	7312406
500	7342307	7312307	500	7342407	7312407
600	7342308	7312308	600	7342408	7312408

17 SPLICE CONNECTOR TMD-50-SC	
PG	HDG
7341502	7311502

18 CONNECTOR PLATE TMD-SC-PL	
PG	HDG
7341511	7311511

19 COVER CLAMP TMD-CO-FC		
Type	PG	HDG
FC	7342602	7312602
FC-V	7342606	7312606

20 DIVIDER TMD-50-DI		
Type	PG	HDG
DI	7343701	7313701
DI-FR	7346201	7316201
DI-FE	7343801	7313801

21 HINGE HORIZONTAL TMD-50-HI-G	
PG	HDG
7341602	7311602

22 HINGE VERTICAL TMD-50-HI-V	
PG	HDG
7341702	7311702

Designation structure							
series	height, mm	element type	width, mm	thickness, mm	length, m	radius	material
TMD	50	CT	100	1,5	3	-	HDG
TMD	50	FE-90	300	1,5	-	R75	PG
Title							
Cable tray TMD - 50 - CT - 100 - 1,5 - 3 - HDG							
FLAT ELBOW 90° TMD - 50 - FE - 90 - 300 - 1,5 - R75 - PG							

Accepted symbols:
 average cable loads
 PG - pre-galvanized steel
 HDG - hot-dip galvanized steel
 Thickness of cable trays: 1,5 mm
 Cover thickness: from 50 to 200 - 1.0 mm; from 300 to 600 - 1.5 mm



23 END CAP TMD-50-EC		
Width	PG	HDG
50	7344909	7314909
100	7344910	7314910
150	7344911	7314911
200	7344912	7314912
300	7344913	7314913
400	7344914	7314914
500	7344915	7314915
600	7344916	7314916

24 REDUCER TMD-50-RP		
Width	PG	HDG
50	7343908	7313908
100	7343909	7313909
150	7343910	7313910
200	7343911	7313911
250	7343912	7313912
300	7343913	7313913
400	7343914	7313914

Cable tray system TMD-50 R=75 SS2/SS4

1 CABLE TRAY TMD-50-CT			2 FLAT ELBOW 90° TMD-50-FE-90			3 FLAT ELBOW 45° TMD-50-FE-45			4 FLAT ELBOW 30° TMD-50-FE-30			5 ELBOW FLEXI 0-90° TMD-50-EF			6 FLEXI RISER TMD-50-FR		
Width	SS2	SS4	Width	SS2	SS4	Width	SS2	SS4	Width	SS2	SS4	Width	SS2	SS4	Width	SS2	SS4
50	7320709	7330709	50	7320809	7330809	50	7321009	7331009	50	7321109	7331109	50	7326309	7336309	50	7321209	7331209
100	7320710	7330710	100	7320810	7330810	100	7321010	7331010	100	7321110	7331110	100	7326310	7336310	100	7321210	7331210
150	7320711	7330711	150	7320811	7330811	150	7321011	7331011	150	7321111	7331111	150	7326311	7336311	150	7321211	7331211
200	7320712	7330712	200	7320812	7330812	200	7321012	7331012	200	7321112	7331112	200	7326312	7336312	200	7321212	7331212
300	7320713	7330713	300	7320813	7330813	300	7321013	7331013	300	7321113	7331113	300	7326313	7336313	300	7321213	7331213
400	7320714	7330714	400	7320814	7330814	400	7321014	7331014	400	7321114	7331114	400	7326314	7336314	400	7321214	7331214
500	7320715	7330715	500	7320815	7330815	500	7321015	7331015	500	7321115	7331115	500	7326315	7336315	500	7321215	7331215
600	7320716	7330716	600	7320816	7330816	600	7321016	7331016	600	7321116	7331116	600	7326316	7336316	600	7321216	7331216

7 COVER TMD-CO			8 COVER 90° TMD-CO-90			9 COVER 45° TMD-CO-45			10 COVER 30° TMD-CO-30			11 COVER 0-90° TMD-CO-EF			12 COVER RISER TMD-CO-FR		
Width	SS2	SS4	Width	SS2	SS4	Width	SS2	SS4	Width	SS2	SS4	Width	SS2	SS4	Width	SS2	SS4
50	7322109	7332109	50	7322217	7332217	50	7323601	7333601	50	7326117	7336117	50	7326417	7336417	50	7322517	7332517
100	7322111	7332111	100	7322219	7332219	100	7323603	7333603	100	7326119	7336119	100	7326419	7336419	100	7322519	7332519
150	7322112	7332112	150	7322220	7332220	150	7323604	7333604	150	7326120	7336120	150	7326420	7336420	150	7322520	7332520
200	7322113	7332113	200	7322221	7332221	200	7323605	7333605	200	7326121	7336121	200	7326421	7336421	200	7322521	7332521
300	7322105	7332105	300	7322205	7332205	300	7323612	7333612	300	7326105	7336105	300	7326405	7336405	300	7322505	7332505
400	7322106	7332106	400	7322206	7332206	400	7323613	7333613	400	7326106	7336106	400	7326406	7336406	400	7322506	7332506
500	7322107	7332107	500	7322207	7332207	500	7323614	7333614	500	7326107	7336107	500	7326407	7336407	500	7322507	7332507
600	7322108	7332108	600	7322208	7332208	600	7323615	7333615	600	7326108	7336108	600	7326408	7336408	600	7322508	7332508

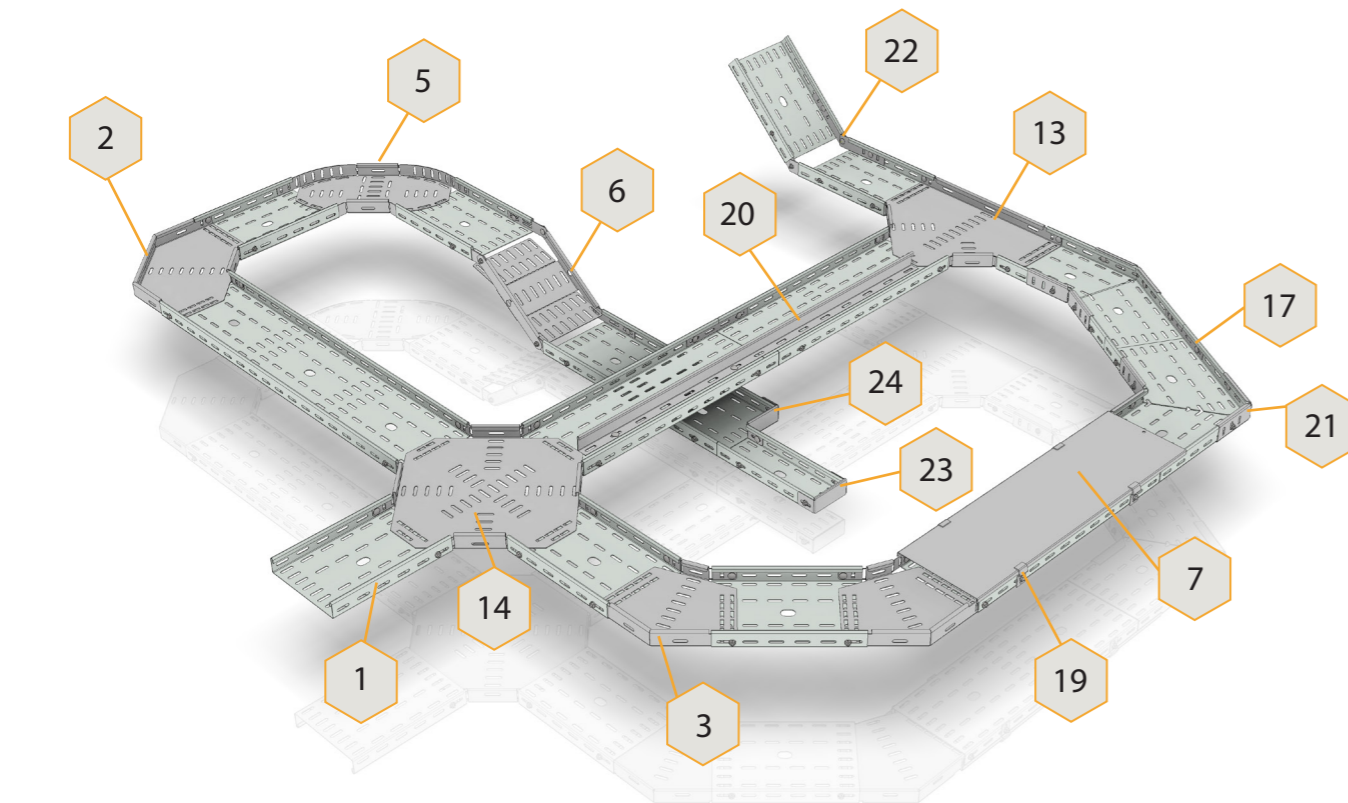
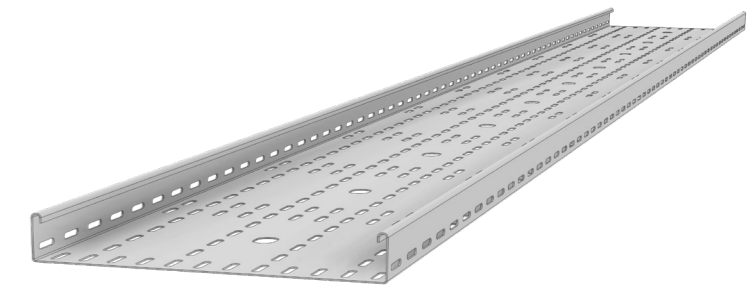

17 SPLICE CONNECTOR TMD-50-SC		
Type	SS2	SS4
SS2	7321502	7331502
SS4	7331502	7331502

18 CONNECTOR PLATE TMD-SC-PL			
Type	SS2	SS4	Type
SS2	7321511	7331511	SS4
SS4	7331511	7331511	SS2

19 COVER CLAMP TMD-CO-FC			
Type	SS2	SS4	Type
FC	7322602	7332602	FC-V
FC-V	7322606	7332606	FC

20 DIVIDER TMD-50-DI			
Type	SS2	SS4	Type
DI	7343701	7313701	DI-FR
DI-FR	7346201	7316201	DI-FE
DI-FE	7343801	7313801	DI

13 T-PIECE TMD-50-TE		
Width	SS2	SS4
50	7321309	7331309
100	7321310	7331310
150	7321311	7331311
200	7321312	7331312
300	7321313	7331313
400	7321314	7331314
500	7321315	7331315
600	7321316	7331316

14 X-PIECE TMD-50-XE		
Width	SS2	SS4
50	7321409	7331409
100	7321410	7331410
150	7321411	7331411
200	7321412	7331412
300	7321413	7331413
400	7321414	7331414
500	7321415	7331415
600	7321416	7331416

15 COVER T TMD-CO-TE		
Width	SS2	SS4
50	7322317	7332317
100	7322319	7332319
150	7322320	7332320
200	7322321	7332321
300	7322305	7332305
400	7322306	7332306
500	7322307	7332307
600	7322308	7332308

16 COVER X TMD-CO-XE		
Width	SS2	SS4
50	7322417	7332417
100	7322419	7332419
150	7322420	7332420
200	7322421	7332421
300	7322405	7332405
400	7322406	7332406
500	7322407	7332407
600	7322408	7332408

Designation structure							
series	height, mm	element type	width, mm	thickness, mm	length, m	radius	material
TMD	50	CT	100	1,5	3	-	SS4
TMD	50	FE-90	300	1,5	-	R75	SS2
Title							
Cable tray TMD - 50 - CT - 100 - 1,5 - 3 - SS4							
FLAT ELBOW 90° TMD - 50 - FE - 90 - 300 - 1,5 - R75 - SS2							

Accepted symbols:

average cable loads

SS2 - stainless steel, resistance class A*

SS4 - stainless steel, resistance class D*

Cable tray thickness: 1.5 mm

Cover thickness: from 50 to 200 - 1.0 mm; from 300 to 600 - 1.5 mm

* - corrosion resistance classification according to GOST R 52868-2021



23 END CAP TMD-50-EC		
Width	SS2	SS4
50	7324909	7334909
100	7324910	7334910
150	7324911	7334911
200	7324912	7334912
300	7324913	7334913
400	7324914	7334914
500	7324915	7334915
600	7324916	7334916

24 REDUCER TMD-50-RP		
Width	SS2	SS4
50	7323908	7333908
100	7323909	7333909
150	7323910	7333910
200	7323911	7333911
250	7323912	7333912
300	7323913	7333913
400	7323914	7333914

Cable tray system TMD-60 R=75 PG/ HDG

1 CABLE TRAY TMD-60-CT		
Width	PG	HDG
75	7340738	7310738
100	7340717	7310717
150	7340718	7310718
200	7340719	7310719
300	7340720	7310720
400	7340721	7310721
500	7340722	7310722
600	7340723	7310723

2 FLAT ELBOW 90° TMD-60-FE-90		
Width	PG	HDG
75	7340875	7310875
100	7340817	7310817
150	7340818	7310818
200	7340819	7310819
300	7340820	7310820
400	7340821	7310821
500	7340822	7310822
600	7340823	7310823

3 FLAT ELBOW 45° TMD-60-FE-45		
Width	PG	HDG
75	7341075	7311075
100	7341017	7311017
150	7341018	7311018
200	7341019	7311019
300	7341020	7311020
400	7341021	7311021
500	7341022	7311022
600	7341023	7311023

4 FLAT ELBOW 30° TMD-60-FE-30		
Width	PG	HDG
75	7341175	7311175
100	7341117	7311117
150	7341118	7311118
200	7341119	7311119
300	7341120	7311120
400	7341121	7311121
500	7341122	7311122
600	7341123	7311123

5 ELBOW FLEXI 0-90° TMD-60-EF		
Width	PG	HDG
75	7346375	7316375
100	7346317	7316317
150	7346318	7316318
200	7346319	7316319
300	7346320	7316320
400	7346321	7316321
500	7346322	7316322
600	7346323	7316323

6 FLEXI RISER TMD-60-FR		
Width	PG	HDG
75	7341275	7311275
100	7341217	7311217
150	7341218	7311218
200	7341219	7311219
300	7341220	7311220
400	7341221	7311221
500	7341222	7311222
600	7341223	7311223

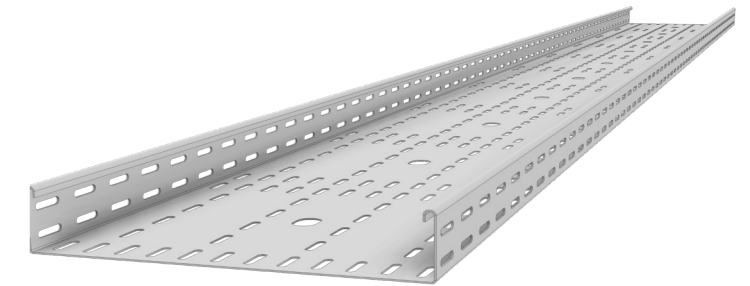

7 COVER TMD-CO		
Width	PG	HDG
75	7342110	7312110
100	7342111	7312111
150	7342112	7312112
200	7342113	7312113
300	7342105	7312105
400	7342106	7312106
500	7342107	7312107
600	7342108	7312108

8 COVER 90° TMD-CO-90		
Width	PG	HDG
75	7342218	7312218
100	7342219	7312219
150	7342220	7312220
200	7342221	7312221
300	7342205	7312205
400	7342206	7312206
500	7342207	7312207
600	7342208	7312208

9 COVER 45° TMD-CO-45		
Width	PG	HDG
75	7343602	7313602
100	7343603	7313603
150	7343604	7313604
200	7343605	7313605
300	7343612	7313612
400	7343613	7313613
500	7343614	7313614
600	7343615	7313615

10 COVER 30° TMD-CO-30		
Width	PG	HDG
75	7346118	7316118
100	7346119	7316119
150	7346120	7316120
200	7346121	7316121
300	7346105	7316105
400	7346106	7316106
500	7346107	7316107
600	7346108	7316108

11 COVER 0-90° TMD-CO-EF		
Width	PG	HDG
75	7346418	7316418
100	7346419	7316419
150	7346420	7316420
200	7346421	7316421
300	7346405	7316405
400	7346406	7316406
500	7346407	7316407
600	7346408	7316408

12 COVER RISER TMD-CO-FR		
Width	PG	HDG
75	7342518	7312518
100	7342519	7312519
150	7342520	7312520
200	7342521	7312521
300	7342505	7312505
400	7342506	7312506
500	7342507	7312507
600	7342508	7312508

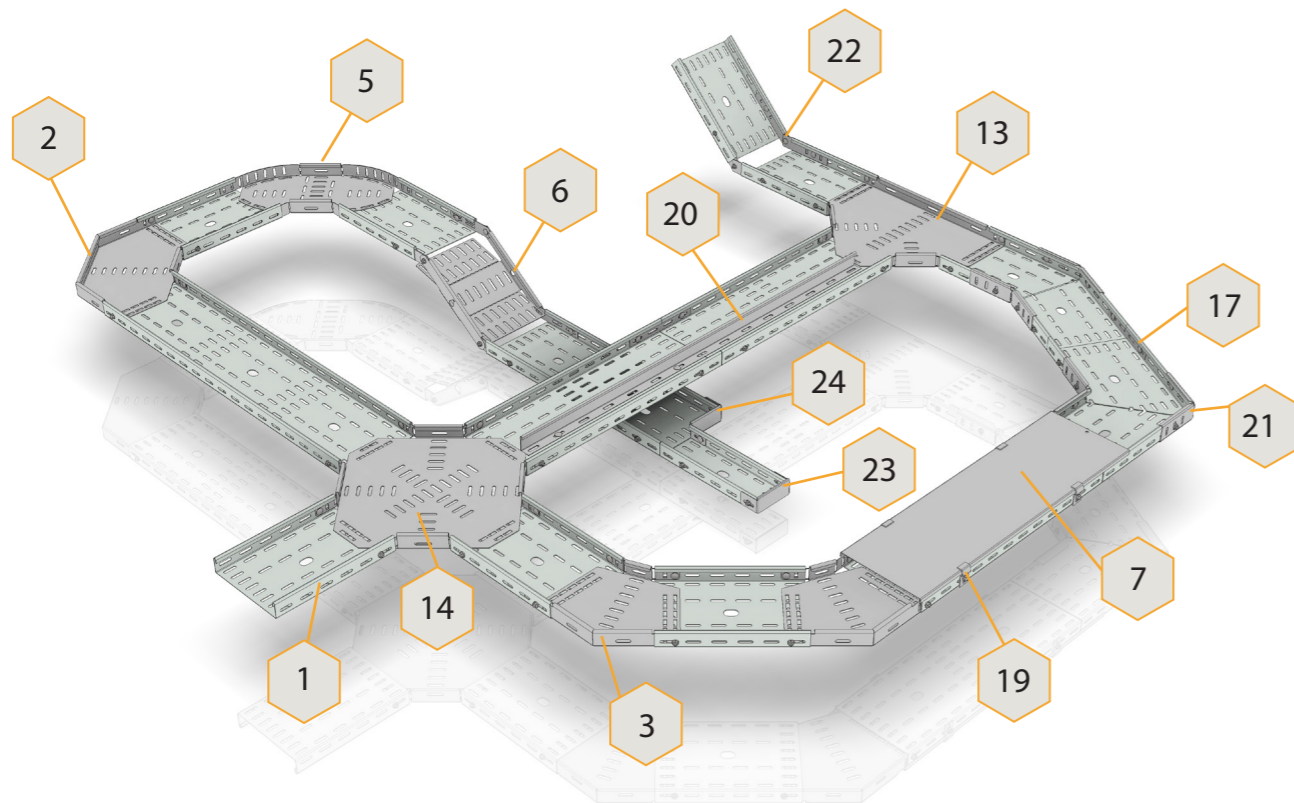

13 T-PIECE TMD-60-TE		
Width	PG	HDG
75	7341375	7311375
100	7341317	7311317
150	7341318	7311318
200	7341319	7311319
300	7341320	7311320
400	7341321	7311321
500	7341322	7311322
600	7341323	7311323

14 X-PIECE TMD-60-XE		
Width	PG	HDG
75	7641475	7311475
100	7341417	7311417
150	7341418	7311418
200	7341419	7311419
300	7341420	7311420
400	7341421	7311421
500	7341422	7311422
600	7341423	7311423

15 COVER T TMD-CO-TE		
Width	PG	HDG
75	7342318	7312318
100	7342319	7312319
150	7342320	7312320
200	7342321	7312321
300	7342305	7312305
400	7342306	7312306
500	7342307	7312307
600	7342308	7312308

16 COVER X TMD-CO-XE		
Width	PG	HDG
75	7342418	7312418
100	7342419	7312419
150	7342420	7312420
200	7342421	7312421
300	7342405	7312405
400	7342406	7312406
500	7342407	7312407
600	7342408	7312408

17 SPLICE CONNECTOR TMD-60-SC	
PG	HDG
7341503	7311503

18 CONNECTOR PLATE TMD-SC-PL	
PG	HDG
7341511	7311511

19 COVER CLAMP TMD-CO-FC	
SS2	SS4
7342601	7312601

20 DIVIDER TMD-60-DI		
Type	PG	HDG
DI	7343703	7313703
DI-FR	7346203	7316203
DI-FE	7343803	7313803

21 HINGE HORIZONTAL TMD-60-HI-G	
PG	HDG
7341603	7311603

22 HINGE VERTICAL TMD-60-HI-V	
PG	HDG
7341703	7311703

Designation structure							
series	height, mm	element type	width, mm	thickness, mm	length, m	radius	material
TMD	60	CT	100	1,5	3	-	HDG
TMD	60	FE-90	300	1,5	-	R75	PG
Title							
Cable tray TMD - 60 - CT - 100 - 1,5 - 3 - HDG							
FLAT ELBOW 90° TMD - 60 - FE - 90 - 300 - 1,5 - R75 - PG							

Accepted symbols:
 high loads from cables and external influences
 PG - pre-galvanized steel
 HDG - hot-dip galvanized steel
 Thickness of cable trays: 1,5 mm
 Cover thickness: from 50 to 200 - 1.0 mm; from 300 to 600 - 1.5 mm



23 END CAP TMD-60-EC		
Width	PG	HDG
75	7344917	7314917
100	7344918	7314918
150	7344919	7314919
200	7344920	7314920
300	7344921	7314921
400	7344922	7314922
500	7344923	7314923
600	7344924	7314924

24 REDUCER TMD-60-RP		
Width	PG	HDG
50	7343915	7313915
100	7343916	7313916
150	7343917	7313917
200	7343918	7313918
250	7343919	7313919
300	7343920	7313920
400	7343921	7313921

Cable tray system TMD-60 R=75 SS2/SS4



1 CABLE TRAY TMD-60-CT		
Width	SS2	SS4
75	7320738	7330738
100	7320717	7330717
150	7320718	7330718
200	7320719	7330719
300	7320720	7330720
400	7320721	7330721
500	7320722	7330722
600	7320723	7330723

2 FLAT ELBOW 90° TMD-60-FE-90		
Width	SS2	SS4
75	7320875	7330875
100	7320817	7330817
150	7320818	7330818
200	7320819	7330819
300	7320820	7330820
400	7320821	7330821
500	7320822	7330822
600	7320823	7330823

3 FLAT ELBOW 45° TMD-60-FE-45		
Width	SS2	SS4
75	7321075	7331075
100	7321017	7331017
150	7321018	7331018
200	7321019	7331019
300	7321020	7331020
400	7321021	7331021
500	7321022	7331022
600	7321023	7331023

4 FLAT ELBOW 30° TMD-60-FE-30		
Width	SS2	SS4
75	7321175	7331175
100	7321117	7331117
150	7321118	7331118
200	7321119	7331119
300	7321120	7331120
400	7321121	7331121
500	7321122	7331122
600	7321123	7331123

5 ELBOW FLEXI 0-90° TMD-60-EF		
Width	SS2	SS4
75	7326375	7336375
100	7326317	7336317
150	7326318	7336318
200	7326319	7336319
300	7326320	7336320
400	7326321	7336321
500	7326322	7336322
600	7326323	7336323

6 FLEXI RISER TMD-60-FR		
Width	SS2	SS4
75	7321275	7331275
100	7321217	7331217
150	7321218	7331218
200	7321219	7331219
300	7321220	7331220
400	7321221	7331221
500	7321222	7331222
600	7321223	7331223

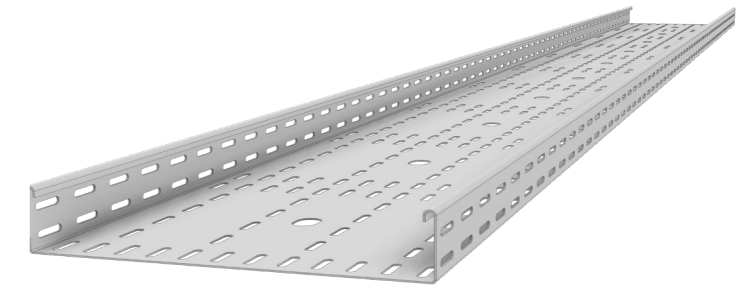

7 COVER TMD-CO		
Width	SS2	SS4
75	7322110	7332110
100	7322111	7332111
150	7322112	7332112
200	7322113	7332113
300	7322105	7332105
400	7322106	7332106
500	7322107	7332107
600	7322108	7332108

8 COVER 90° TMD-CO-90		
Width	SS2	SS4
75	7322218	7332218
100	7322219	7332219
150	7322220	7332220
200	7322221	7332221
300	7322205	7332205
400	7322206	7332206
500	7322207	7332207
600	7322208	7332208

9 COVER 45° TMD-CO-45		
Width	SS2	SS4
75	7323602	7333602
100	7323603	7333603
150	7323604	7333604
200	7323605	7333605
300	7323612	7333612
400	7323613	7333613
500	7323614	7333614
600	7323615	7333615

10 COVER 30° TMD-CO-30		
Width	SS2	SS4
75	7326118	7336118
100	7326119	7336119
150	7326120	7336120
200	7326121	7336121
300	7326105	7336105
400	7326106	7336106
500	7326107	7336107
600	7326108	7336108

11 COVER 0-90° TMD-CO-EF		
Width	SS2	SS4
75	7326418	7336418
100	7326419	7336419
150	7326420	7336420
200	7326421	7336421
300	7326405	7336405
400	7326406	7336406
500	7326407	7336407
600	7326408	7336408

12 COVER RISER TMD-CO-FR		
Width	SS2	SS4
75	7322518	7332518
100	7322519	7332519
150	7322520	7332520
200	7322521	7332521
300	7322505	7332505
400	7322506	7332506
500	7322507	7332507
600	7322508	7332508

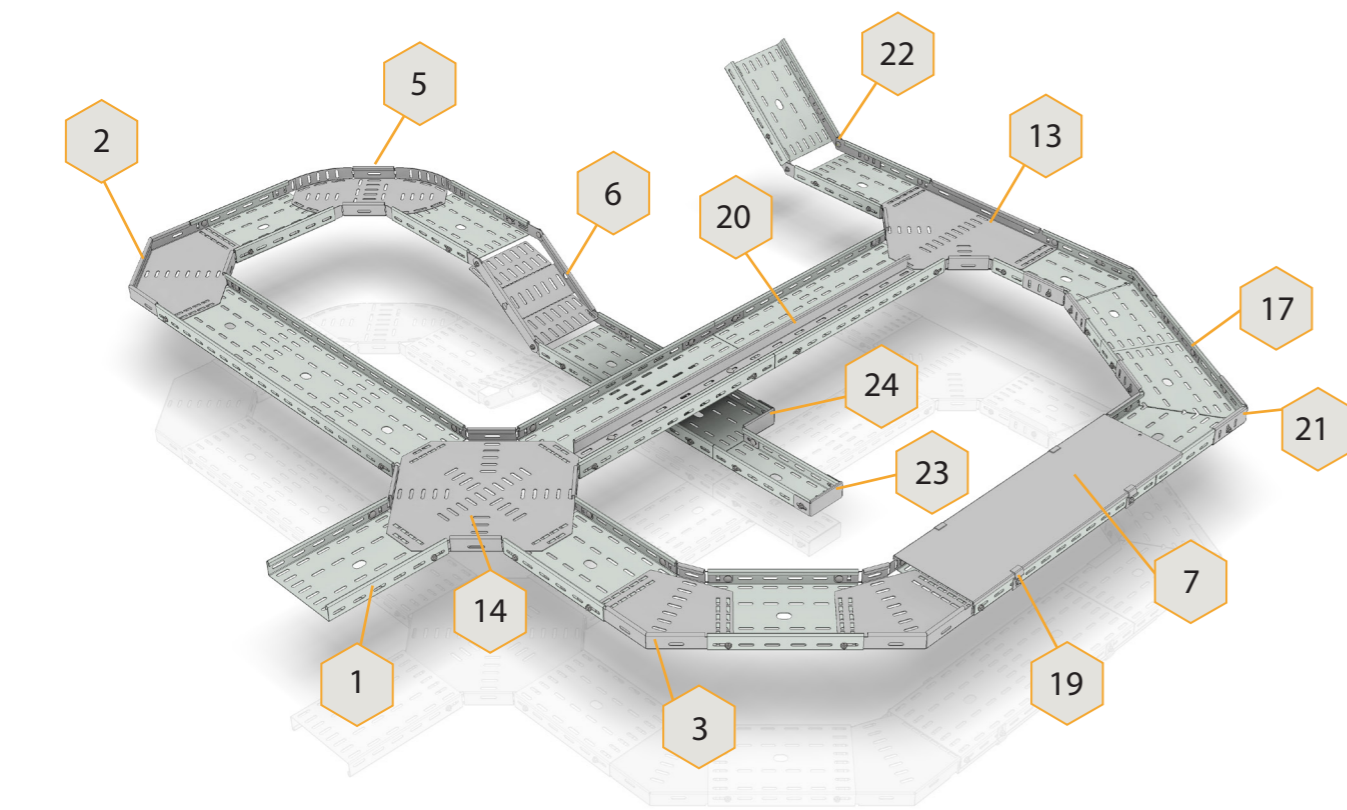

13 T-PIECE TMD-60-TE		
Width	SS2	SS4
75	7321375	7331375
100	7321317	7331317
150	7321318	7331318
200	7321319	7331319
300	7321320	7331320
400	7321321	7331321
500	7321322	7331322
600	7321323	7331323

14 X-PIECE TMD-60-XE		
Width	SS2	SS4
75	7621475	7631475
100	7321417	7331417
150	7321418	7331418
200	7321419	7331419
300	7321420	7331420
400	7321421	7331421
500	7321422	7331422
600	7321423	7331423

15 COVER T TMD-CO-TE		
Width	SS2	SS4
75	7322318	7332318
100	7322319	7332319
150	7322320	7332320
200	7322321	7332321
300	7322305	7332305
400	7322306	7332306
500	7322307	7332307
600	7322308	7332308

16 COVER X TMD-CO-XE		
Width	SS2	SS4
75	7322418	7332418
100	7322419	7332419
150	7322420	7332420
200	7322421	7332421
300	7322405	7332405
400	7322406	7332406
500	7322407	7332407
600	7322408	7332408

17 SPLICE CONNECTOR TMD-60-SC		
SS2	SS4	
7321503	7331503	

18 CONNECTOR PLATE TMD-SC-PL		
SS2	SS4	
7321511	7331511	

19 COVER CLAMP TMD-CO-FC		
SS2	SS4	
7322601	7332601	

20 DIVIDER TMD-60-DI		
Type	SS2	SS4
DI	7323703	7333703
DI-FR	7326203	7336203
DI-FE	7323803	7333803

21 HINGE HORIZONTAL TMD-60-HI-G		
SS2	SS4	
7321603	7331603	

22 HINGE VERTICAL TMD-60-HI-V		
SS2	SS4	
7321703	7331703	

Designation structure							
series	height, mm	element type	width, mm	thickness, mm	length, m	radius	material
TMD	60	CT	100	1,5	3	-	SS4
TMD	60	FE-90	300	1,5	-	R75	SS2
Title							
Cable tray TMD - 60 - CT - 100 - 1,5 - 3 - SS4							
FLAT ELBOW 90° TMD - 60 - FE - 90 - 300 - 1,5 - R75 - SS2							

Accepted symbols:
 high loads from cables and external influences
 SS2 - stainless steel, resistance class A*
 SS4 - stainless steel, resistance class D*
 Cable tray thickness: 1.5 mm
 Cover thickness: from 50 to 200 - 1.0 mm; from 300 to 600 - 1.5 mm
 * - corrosion resistance classification according to GOST R 52868-2021



23 END CAP TMD-60-EC		
Width	SS2	SS4
75	7324917	7334917
100	7324918	7334918
150	7324919	7334919
200	7324920	7334920
300	7324921	7334921
400	7324922	7334922
500	7324923	7334923
600	7324924	7334924

24 REDUCER TMD-60-RP		
Width	SS2	SS4
50	7323915	7333915
100	7323916	7333916
150	7323917	7333917
200	7323918	7333918
250	7323919	7333919
300	7323920	7333920
400	7323921	7333921

Cable tray system TMD-75 R=75 PG/ HDG

1 CABLE TRAY TMD-75-CT		
Width	PG	HDG
75	7340739	7310739
100	7340724	7310724
150	7340725	7310725
200	7340726	7310726
300	7340727	7310727
400	7340728	7310728
500	7340729	7310729
600	7340730	7310730

2 FLAT ELBOW 90° TMD-75-FE-90		
Width	PG	HDG
75	7340876	7310876
100	7340824	7310824
150	7340825	7310825
200	7340826	7310826
300	7340827	7310827
400	7340828	7310828
500	7340829	7310829
600	7340830	7310830

3 FLAT ELBOW 45° TMD-75-FE-45		
Width	PG	HDG
75	7341076	7311076
100	7341024	7311024
150	7341025	7311025
200	7341026	7311026
300	7341027	7311027
400	7341028	7311028
500	7341029	7311029
600	7341030	7311030

4 FLAT ELBOW 30° TMD-75-FE-30		
Width	PG	HDG
75	7341176	7311176
100	7341124	7311124
150	7341125	7311125
200	7341126	7311126
300	7341127	7311127
400	7341128	7311128
500	7341129	7311129
600	7341130	7311130

5 ELBOW FLEXI 0-90° TMD-75-EF		
Width	PG	HDG
75	7346376	7316376
100	7346324	7316324
150	7346325	7316325
200	7346326	7316326
300	7346327	7316327
400	7346328	7316328
500	7346329	7316329
600	7346330	7316330

6 FLEXI RISER TMD-75-FR		
Width	PG	HDG
75	7341276	7311276
100	7341224	7311224
150	7341225	7311225
200	7341226	7311226
300	7341227	7311227
400	7341228	7311228
500	7341229	7311229
600	7341230	7311230

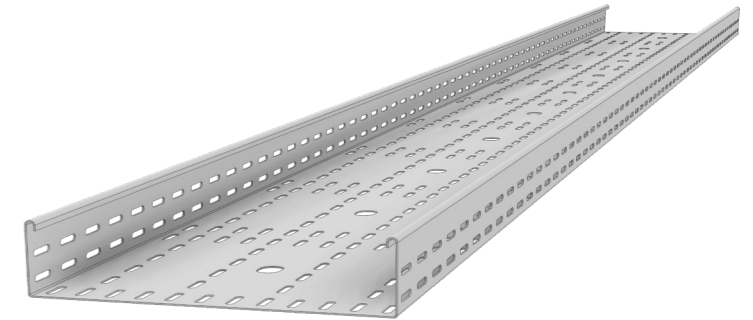

7 COVER TMD-CO		
Width	PG	HDG
75	7342110	7312110
100	7342111	7312111
150	7342112	7312112
200	7342113	7312113
300	7342105	7312105
400	7342106	7312106
500	7342107	7312107
600	7342108	7312108

8 COVER 90° TMD-CO-90		
Width	PG	HDG
75	7342218	7312218
100	7342219	7312219
150	7342220	7312220
200	7342221	7312221
300	7342205	7312205
400	7342206	7312206
500	7342207	7312207
600	7342208	7312208

9 COVER 45° TMD-CO-45		
Width	PG	HDG
75	7343602	7313602
100	7343603	7313603
150	7343604	7313604
200	7343605	7313605
300	7343612	7313612
400	7343613	7313613
500	7343614	7313614
600	7343615	7313615

10 COVER 30° TMD-CO-30		
Width	PG	HDG
75	7346118	7316118
100	7346119	7316119
150	7346120	7316120
200	7346121	7316121
300	7346105	7316105
400	7346106	7316106
500	7346107	7316107
600	7346108	7316108

11 COVER 0-90° TMD-CO-EF		
Width	PG	HDG
75	7346418	7316418
100	7346419	7316419
150	7346420	7316420
200	7346421	7316421
300	7346405	7316405
400	7346406	7316406
500	7346407	7316407
600	7346408	7316408

12 COVER RISER TMD-CO-FR		
Width	PG	HDG
75	7342518	7312518
100	7342519	7312519
150	7342520	7312520
200	7342521	7312521
300	7342505	7312505
400	7342506	7312506
500	7342507	7312507
600	7342508	7312508

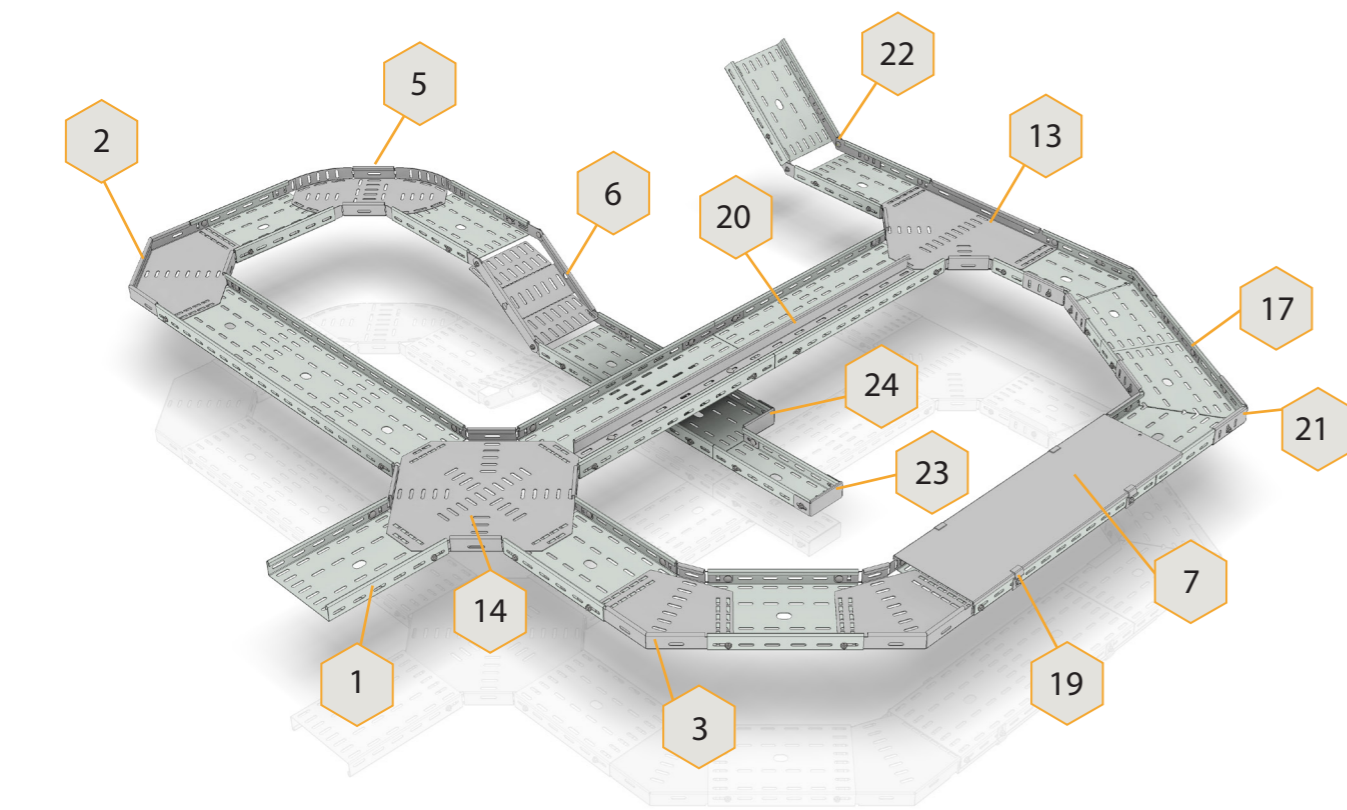

13 T-PIECE TMD-75-TE		
Width	PG	HDG
75	7341376	7311376
100	7341324	7311324
150	7341325	7311325
200	7341326	7311326
300	7341327	7311327
400	7341328	7311328
500	7341329	7311329
600	7341330	7311330

14 X-PIECE TMD-75-XE		
Width	PG	HDG
75	7641476	7311476
100	7341424	7311424
150	7341425	7311425
200	7341426	7311426
300	7341427	7311427
400	7341428	7311428
500	7341429	7311429
600	7341430	7311430

15 COVER T TMD-CO-TE		
Width	PG	HDG
75	7342318	7312318
100	7342319	7312319
150	7342320	7312320
200	7342321	7312321
300	7342305	7312305
400	7342306	7312306
500	7342307	7312307
600	7342308	7312308

16 COVER X TMD-CO-XE		
Width	PG	HDG
75	7342418	7312418
100	7342419	7312419
150	7342420	7312420
200	7342421	7312421
300	7342405	7312405
400	7342406	7312406
500	7342407	7312407
600	7342408	7312408

17 SPLICE CONNECTOR TMD-75-SC	
PG	HDG
7341504	7311504

18 CONNECTOR PLATE TMD-SC-PL	
PG	HDG
7341511	7311511

19 COVER CLAMP TMD-CO-FC	
SS2	SS4
7342602	7312602

20 DIVIDER TMD-75-DI		
Type	PG	HDG
DI	7343704	7313704
DI-FR	7346204	7316204
DI-FE	7343804	7313804

21 HINGE HORIZONTAL TMD-75-HI-G	
PG	HDG
7341604	7311604

22 HINGE VERTICAL TMD-75-HI-V	
PG	HDG
7341704	7311704

Designation structure							
series	height, mm	element type	width, mm	thickness, mm	length, m	radius	material
TMD	75	CT	100	1,5	3	-	HDG
TMD	75	FE-90	300	1,5	-	R75	PG
Title							
Cable tray TMD - 75 - CT - 100 - 1,5 - 3 - HDG							
FLAT ELBOW 90° TMD - 75 - FE - 90 - 300 - 1,5 - R75 - PG							

Accepted symbols:
 high loads from cables and external influences
 PG - pre-galvanized steel
 HDG - hot-dip galvanized steel
 Thickness of cable trays: 1,5 mm
 Cover thickness: from 50 to 200 - 1.0 mm; from 300 to 600 - 1.5 mm



23 END CAP TMD-75-EC		
Width	PG	HDG
75	7344925	7314925
100	7344926	7314926
150	7344927	7314927
200	7344928	7314928
300	7344929	7314929
400	7344930	7314930
500	7344931	7314931
600	7344932	7314932

24 REDUCER TMD-75-RP		
Width	PG	HDG
50	7343922	7313922
100	7343923	7313923
150	7343924	7313924
200	7343925	7313925
250	7343926	7313926
300	7343927	7313927
400	7343928	7313928

Cable tray system TMD-75 R=75 SS2/SS4



1 CABLE TRAY TMD-75-CT		
Width	SS2	SS4
75	7320739	7330739
100	7320724	7330724
150	7320725	7330725
200	7320726	7330726
300	7320727	7330727
400	7320728	7330728
500	7320729	7330729
600	7320730	7330730

2 FLAT ELBOW 90° TMD-75-FE-90		
Width	SS2	SS4
75	7320876	7330876
100	7320824	7330824
150	7320825	7330825
200	7320826	7330826
300	7320827	7330827
400	7320828	7330828
500	7320829	7330829
600	7320830	7330830

3 FLAT ELBOW 45° TMD-75-FE-45		
Width	SS2	SS4
75	7321076	7331076
100	7321024	7331024
150	7321025	7331025
200	7321026	7331026
300	7321027	7331027
400	7321028	7331028
500	7321029	7331029
600	7321030	7331030

4 FLAT ELBOW 30° TMD-75-FE-30		
Width	SS2	SS4
75	7321176	7331176
100	7321124	7331124
150	7321125	7331125
200	7321126	7331126
300	7321127	7331127
400	7321128	7331128
500	7321129	7331129
600	7321130	7331130

5 ELBOW FLEXI 0-90° TMD-75-EF		
Width	SS2	SS4
75	7326376	7336376
100	7326324	7336324
150	7326325	7336325
200	7326326	7336326
300	7326327	7336327
400	7326328	7336328
500	7326329	7336329
600	7326330	7336330

6 FLEXI RISER TMD-75-FR		
Width	SS2	SS4
75	7321276	7331276
100	7321224	7331224
150	7321225	7331225
200	7321226	7331226
300	7321227	7331227
400	7321228	7331228
500	7321229	7331229
600	7321230	7331230

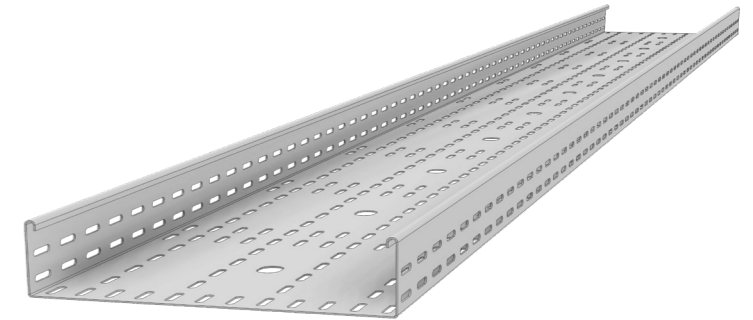

7 COVER TMD-CO		
Width	SS2	SS4
75	7322110	7332110
100	7322111	7332111
150	7322112	7332112
200	7322113	7332113
300	7322105	7332105
400	7322106	7332106
500	7322107	7332107
600	7322108	7332108

8 COVER 90° TMD-CO-90		
Width	SS2	SS4
75	7322218	7332218
100	7322219	7332219
150	7322220	7332220
200	7322221	7332221
300	7322205	7332205
400	7322206	7332206
500	7322207	7332207
600	7322208	7332208

9 COVER 45° TMD-CO-45		
Width	SS2	SS4
75	7323602	7333602
100	7323603	7333603
150	7323604	7333604
200	7323605	7333605
300	7323612	7333612
400	7323613	7333613
500	7323614	7333614
600	7323615	7333615

10 COVER 30° TMD-CO-30		
Width	SS2	SS4
75	7326118	7336118
100	7326119	7336119
150	7326120	7336120
200	7326121	7336121
300	7326105	7336105
400	7326106	7336106
500	7326107	7336107
600	7326108	7336108

11 COVER 0-90° TMD-CO-EF		
Width	SS2	SS4
75	7326418	7336418
100	7326419	7336419
150	7326420	7336420
200	7326421	7336421
300	7326405	7336405
400	7326406	7336406
500	7326407	7336407
600	7326408	7336408

12 COVER RISER TMD-CO-FR		
Width	SS2	SS4
75	7322518	7332518
100	7322519	7332519
150	7322520	7332520
200	7322521	7332521
300	7322505	7332505
400	7322506	7332506
500	7322507	7332507
600	7322508	7332508

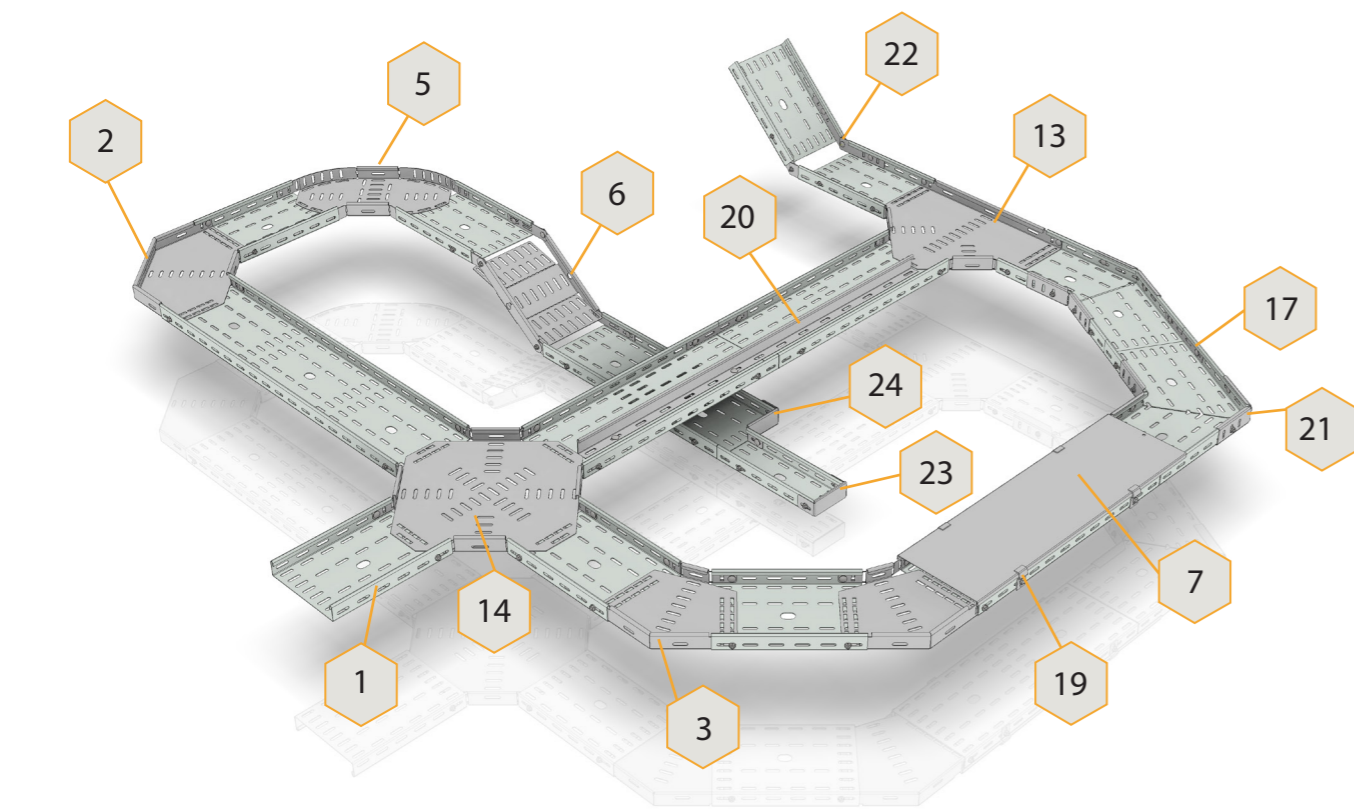

13 T-PIECE TMD-75-TE		
Width	SS2	SS4
75	7321376	7331376
100	7321324	7331324
150	7321325	7331325
200	7321326	7331326
300	7321327	7331327
400	7321328	7331328
500	7321329	7331329
600	7321330	7331330

14 X-PIECE TMD-75-XE		
Width	SS2	SS4
75	7621476	7631476
100	7321424	7331424
150	7321425	7331425
200	7321426	7331426
300	7321427	7331427
400	7321428	7331428
500	7321429	7331429
600	7321430	7331430

15 COVER T TMD-CO-TE		
Width	SS2	SS4
75	7322318	7332318
100	7322319	7332319
150	7322320	7332320
200	7322321	7332321
300	7322305	7332305
400	7322306	7332306
500	7322307	7332307
600	7322308	7332308

16 COVER X TMD-CO-XE		
Width	SS2	SS4
75	7322418	7332418
100	7322419	7332419
150	7322420	7332420
200	7322421	7332421
300	7322405	7332405
400	7322406	7332406
500	7322407	7332407
600	7322408	7332408

17 SPLICE CONNECTOR TMD-75-SC		
SS2	SS4	
7321504	7331504	

18 CONNECTOR PLATE TMD-SC-PL		
SS2	SS4	
7321511	7331511	

19 COVER CLAMP TMD-CO-FC		
SS2	SS4	
7322602	7332602	

20 DIVIDER TMD-75-DI		
Type	SS2	SS4
DI	7323704	7333704
DI-FR	7326204	7336204
DI-FE	7323804	7333804

21 HINGE HORIZONTAL TMD-75-HI-G		
SS2	SS4	
7321604	7331604	

22 HINGE VERTICAL TMD-75-HI-V		
SS2	SS4	
7321704	7331704	

Designation structure							
series	height, mm	element type	width, mm	thickness, mm	length, m	radius	material
TMD	75	CT	100	1,5	3	-	SS4
TMD	75	FE-90	300	1,5	-	R75	SS2
Title							
Cable tray TMD - 75 - CT - 100 - 1,5 - 3 - SS4							
FLAT ELBOW 90° TMD - 75 - FE - 90 - 300 - 1,5 - R75 - SS2							

Accepted symbols:
 high loads from cables and external influences
 SS2 - stainless steel, resistance class A*
 SS4 - stainless steel, resistance class D*
 Cable tray thickness: 1.5 mm
 Cover thickness: from 50 to 200 - 1.0 mm; from 300 to 600 - 1.5 mm
 * - corrosion resistance classification according to GOST R 52868-2021



23 END CAP TMD-75-EC		
Width	SS2	SS4
75	7324925	7334925
100	7324926	7334926
150	7324927	7334927
200	7324928	7334928
300	7324929	7334929
400	7324930	7334930
500	7324931	7334931
600	7324932	7334932

24 REDUCER TMD-75-RP		
Width	SS2	SS4
50	7323922	7333922
100	7323923	7333923
150	7323924	7333924
200	7323925	7333925
250	7323926	7333926
300	7323927	7333927
400	7323928	7333928

Cable tray system TMD-100 R=75 PG/ HDG



1 CABLE TRAY TMD-100-CT		
Width	PG	HDG
100	7340731	7310731
150	7340732	7310732
200	7340733	7310733
300	7340734	7310734
400	7340735	7310735
500	7340736	7310736
600	7340737	7310737

2 FLAT ELBOW 90° TMD-100-FE-90		
Width	PG	HDG
100	7340831	7310831
150	7340832	7310832
200	7340833	7310833
300	7340834	7310834
400	7340835	7310835
500	7340836	7310836
600	7340837	7310837

3 FLAT ELBOW 45° TMD-100-FE-45		
Width	PG	HDG
100	7341031	7311031
150	7341032	7311032
200	7341033	7311033
300	7341034	7311034
400	7341035	7311035
500	7341036	7311036
600	7341037	7311037

4 FLAT ELBOW 30° TMD-100-FE-30		
Width	PG	HDG
100	7341131	7311131
150	7341132	7311132
200	7341133	7311133
300	7341134	7311134
400	7341135	7311135
500	7341136	7311136
600	7341137	7311137

5 ELBOW FLEXI 0-90° TMD-100-EF		
Width	PG	HDG
100	7346331	7316331
150	7346332	7316332
200	7346333	7316333
300	7346334	7316334
400	7346335	7316335
500	7346336	7316336
600	7346337	7316337

6 FLEXI RISER TMD-100-FR		
Width	PG	HDG
100	7341231	7311231
150	7341232	7311232
200	7341233	7311233
300	7341234	7311234
400	7341235	7311235
500	7341236	7311236
600	7341237	7311237

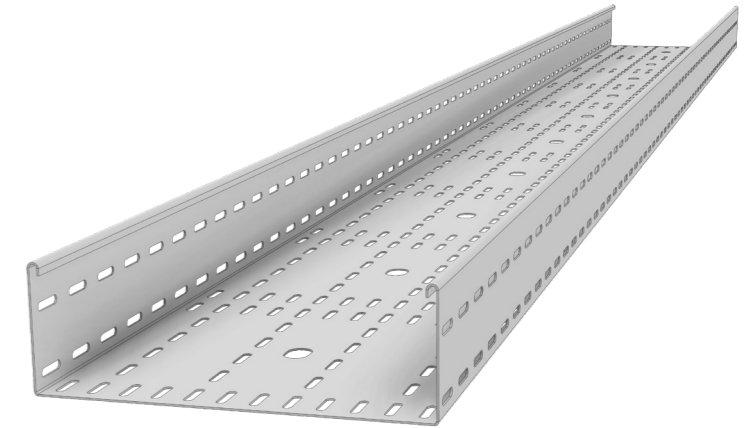

7 COVER TMD-CO		
Width	PG	HDG
75	7342110	7312110
100	7342111	7312111
150	7342112	7312112
200	7342113	7312113
300	7342105	7312105
400	7342106	7312106
500	7342107	7312107
600	7342108	7312108

8 COVER 90° TMD-CO-90		
Width	PG	HDG
75	7342218	7312218
100	7342219	7312219
150	7342220	7312220
200	7342221	7312221
300	7342205	7312205
400	7342206	7312206
500	7342207	7312207
600	7342208	7312208

9 COVER 45° TMD-CO-45		
Width	PG	HDG
75	7343602	7313602
100	7343603	7313603
150	7343604	7313604
200	7343605	7313605
300	7343612	7313612
400	7343613	7313613
500	7343614	7313614
600	7343615	7313615

10 COVER 30° TMD-CO-30		
Width	PG	HDG
75	7346118	7316118
100	7346119	7316119
150	7346120	7316120
200	7346121	7316121
300	7346105	7316105
400	7346106	7316106
500	7346107	7316107
600	7346108	7316108

11 COVER 0-90° TMD-CO-EF		
Width	PG	HDG
75	7346418	7316418
100	7346419	7316419
150	7346420	7316420
200	7346421	7316421
300	7346405	7316405
400	7346406	7316406
500	7346407	7316407
600	7346408	7316408

12 COVER RISER TMD-CO-FR		
Width	PG	HDG
75	7342518	7312518
100	7342519	7312519
150	7342520	7312520
200	7342521	7312521
300	7342505	7312505
400	7342506	7312506
500	7342507	7312507
600	7342508	7312508

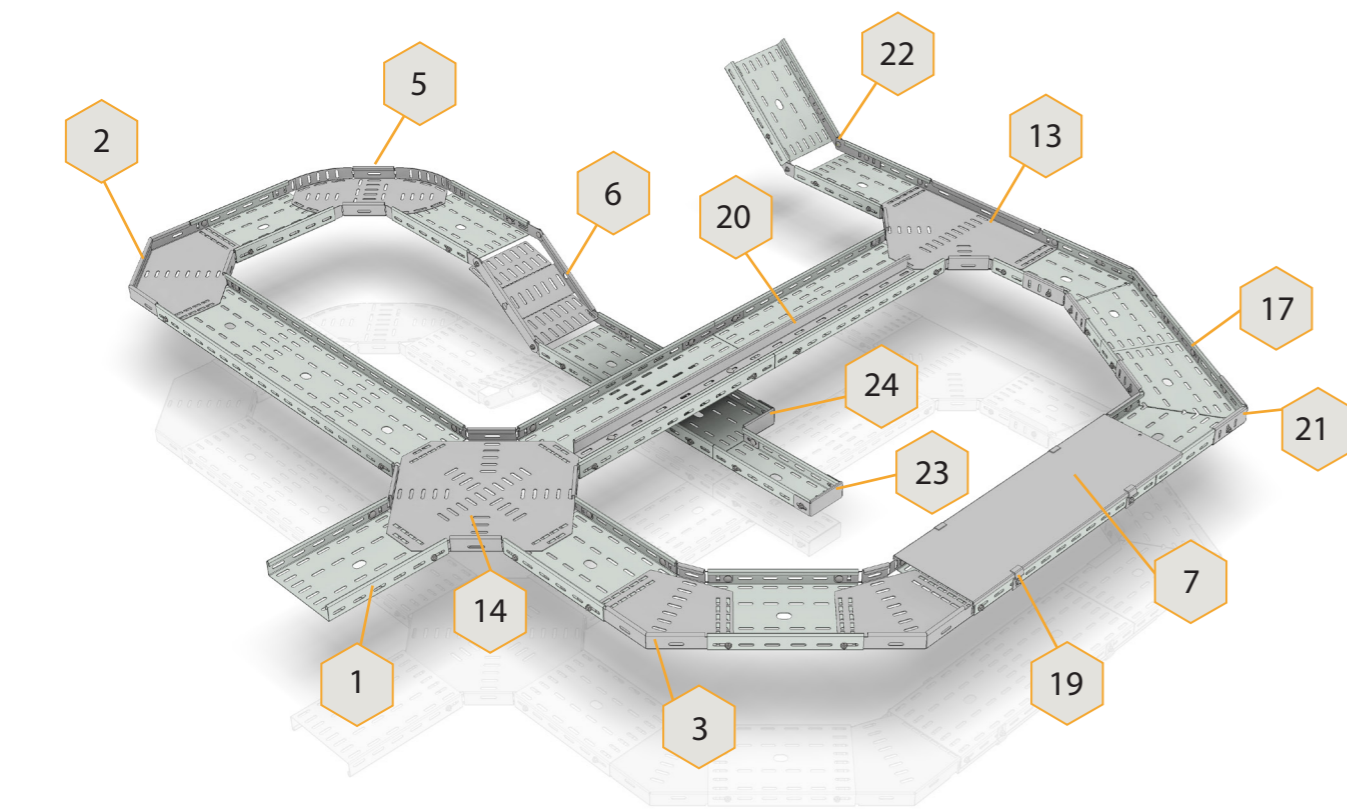

13 T-PIECE TMD-100-TE		
Width	PG	HDG
100	7341331	7311331
150	7341332	7311332
200	7341333	7311333
300	7341334	7311334
400	7341335	7311335
500	7341336	7311336
600	7341337	7311337

14 X-PIECE TMD-100-XE		
Width	PG	HDG
100	7341431	7311431
150	7341432	7311432
200	7341433	7311433
300	7341434	7311434
400	7341435	7311435
500	7341436	7311436
600	7341437	7311437

15 COVER T TMD-CO-TE		
Width	PG	HDG
75	7342318	7312318
100	7342319	7312319
150	7342320	7312320
200	7342321	7312321
300	7342305	7312305
400	7342306	7312306
500	7342307	7312307
600	7342308	7312308

16 COVER X TMD-CO-XE		
Width	PG	HDG
75	7342418	7312418
100	7342419	7312419
150	7342420	7312420
200	7342421	7312421
300	7342405	7312405
400	7342406	7312406
500	7342407	7312407
600	7342408	7312408

17 SPLICE CONNECTOR TMD-100-SC	
PG	HDG
7341505	7311505

18 CONNECTOR PLATE TMD-SC-PL	
PG	HDG
7341511	7311511

19 COVER CLAMP TMD-CO-FC	
PG	HDG
7342602	7312602

20 DIVIDER TMD-100-DI		
Type	PG	HDG
DI	7343705	7313705
DI-FR	7346205	7316205
DI-FE	7343805	7313805

21 HINGE HORIZONTAL TMD-100-HI-G	
PG	HDG
7341605	7311605

22 HINGE VERTICAL TMD-100-HI-V	
PG	HDG
7341705	7311705

Designation structure							
series	height, mm	element type	width, mm	thickness, mm	length, m	radius	material
TMD	100	CT	100	1,5	3	-	HDG
TMD	100	FE-90	300	1,5	-	R75	PG
Title							
Cable tray TMD - 100 - CT - 100 - 1,5 - 3 - HDG							
FLAT ELBOW 90° TMD - 100 - FE - 90 - 300 - 1,5 - R75 - PG							

Accepted symbols:
 high loads from cables and external influences
 PG - pre-galvanized steel
 HDG - hot-dip galvanized steel
 Thickness of cable trays: 1,5 mm
 Cover thickness: from 50 to 200 - 1.0 mm; from 300 to 600 - 1.5 mm



23 END CAP TMD-100-EC		
Width	PG	HDG
100	7344933	7314933
150	7344934	7314934
200	7344935	7314935
300	7344936	7314936
400	7344937	7314937
500	7344938	7314938
600	7344939	7314939

24 REDUCER TMD-100-RP		
Width	PG	HDG
100	7343930	7313930
150	7343931	7313931
200	7343932	7313932
250	7343933	7313933
300	7343934	7313934
400	7343935	7313935

Cable tray system TMD-100 R=75 SS2/SS4

1 CABLE TRAY TMD-100-CT			2 FLAT ELBOW 90° TMD-100-FE-90			3 FLAT ELBOW 45° TMD-100-FE-45			4 FLAT ELBOW 30° TMD-100-FE-30			5 ELBOW FLEXI 0-90° TMD-100-EF			6 FLEXI RISER TMD-100-FR		
Width	SS2	SS4	Width	SS2	SS4	Width	SS2	SS4	Width	SS2	SS4	Width	SS2	SS4	Width	SS2	SS4
100	7320731	7330731	100	7320831	7330831	100	7321031	7331031	100	7321131	7331131	100	7326331	7336331	100	7321231	7331231
150	7320732	7330732	150	7320832	7330832	150	7321032	7331032	150	7321132	7331132	150	7326332	7336332	150	7321232	7331232
200	7320733	7330733	200	7320833	7330833	200	7321033	7331033	200	7321133	7331133	200	7326333	7336333	200	7321233	7331233
300	7320734	7330734	300	7320834	7330834	300	7321034	7331034	300	7321134	7331134	300	7326334	7336334	300	7321234	7331234
400	7320735	7330735	400	7320835	7330835	400	7321035	7331035	400	7321135	7331135	400	7326335	7336335	400	7321235	7331235
500	7320736	7330736	500	7320836	7330836	500	7321036	7331036	500	7321136	7331136	500	7326336	7336336	500	7321236	7331236
600	7320737	7330737	600	7320837	7330837	600	7321037	7331037	600	7321137	7331137	600	7326337	7336337	600	7321237	7331237

7 COVER TMD-CO			8 COVER 90° TMD-CO-90			9 COVER 45° TMD-CO-45			10 COVER 30° TMD-CO-30			11 COVER 0-90° TMD-CO-EF			12 COVER RISER TMD-CO-FR		
Width	SS2	SS4	Width	SS2	SS4	Width	SS2	SS4	Width	SS2	SS4	Width	SS2	SS4	Width	SS2	SS4
75	7322110	7332110	75	7322218	7332218	75	7323602	7333602	75	7326118	7336118	75	7326418	7336418	75	7322518	7332518
100	7322111	7332111	100	7322219	7332219	100	7323603	7333603	100	7326119	7336119	100	7326419	7336419	100	7322519	7332519
150	7322112	7332112	150	7322220	7332220	150	7323604	7333604	150	7326120	7336120	150	7326420	7336420	150	7322520	7332520
200	7322113	7332113	200	7322221	7332221	200	7323605	7333605	200	7326121	7336121	200	7326421	7336421	200	7322521	7332521
300	7322105	7332105	300	7322205	7332205	300	7323612	7333612	300	7326105	7336105	300	7326405	7336405	300	7322505	7332505
400	7322106	7332106	400	7322206	7332206	400	7323613	7333613	400	7326106	7336106	400	7326406	7336406	400	7322506	7332506
500	7322107	7332107	500	7322207	7332207	500	7323614	7333614	500	7326107	7336107	500	7326407	7336407	500	7322507	7332507
600	7322108	7332108	600	7322208	7332208	600	7323615	7333615	600	7326108	7336108	600	7326408	7336408	600	7322508	7332508

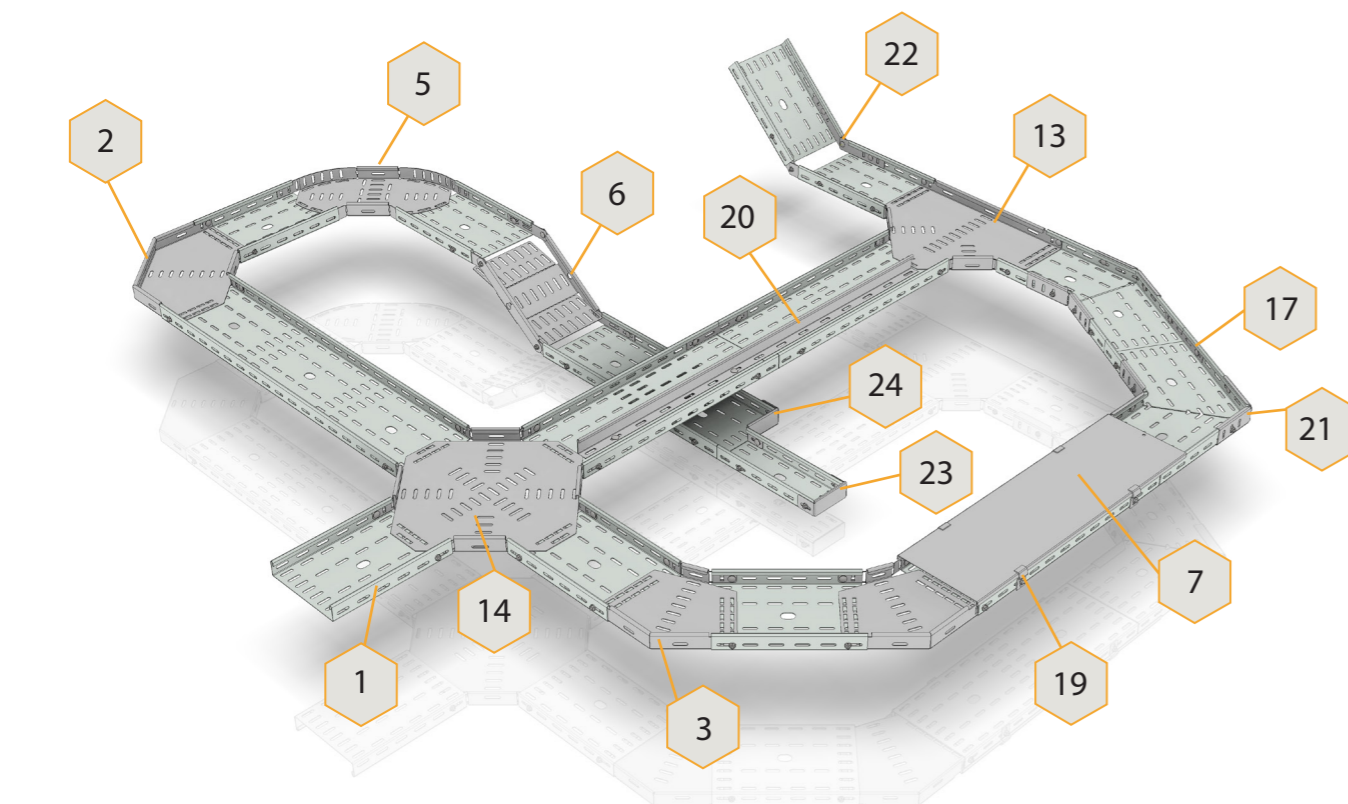
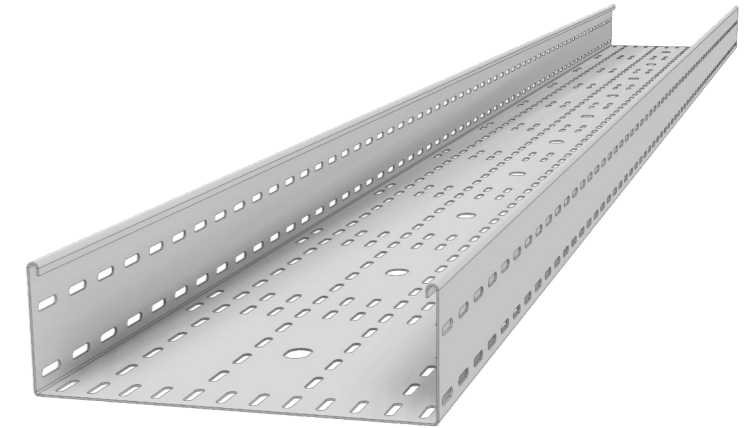

17 SPLICE CONNECTOR TMD-100-SC		
SS2	SS4	
7321505	7331505	

18 CONNECTOR PLATE TMD-SC-PL		
SS2	SS4	
7321511	7331511	

19 COVER CLAMP TMD-CO-FC		
SS2	SS4	
7322602	7332602	

20 DIVIDER TMD-100-DI		
Type	SS2	SS4
DI	7323705	7333705
DI-FR	7326205	7336205
DI-FE	7323805	7333805

13 T-PIECE TMD-100-TE		
Width	SS2	SS4
100	7321331	7331331
150	7321332	7331332
200	7321333	7331333
300	7321334	7331334
400	7321335	7331335
500	7321336	7331336
600	7321337	7331337

14 X-PIECE TMD-100-XE		
Width	SS2	SS4
100	7321431	7331431
150	7321432	7331432
200	7321433	7331433
300	7321434	7331434
400	7321435	7331435
500	7321436	7331436
600	7321437	7331437

15 COVER T TMD-CO-TE		
Width	SS2	SS4
75	7322318	7332318
100	7322319	7332319
150	7322320	7332320
200	7322321	7332321
300	7322305	7332305
400	7322306	7332306
500	7322307	7332307
600	7322308	7332308

16 COVER X TMD-CO-XE		
Width	SS2	SS4
75	7322418	7332418
100	7322419	7332419
150	7322420	7332420
200	7322421	7332421
300	7322405	7332405
400	7322406	7332406
500	7322407	7332407
600	7322408	7332408

Designation structure							
series	height, mm	element type	width, mm	thickness, mm	length, m	radius	material
TMD	100	CT	100	1,5	3	-	SS2
TMD	100	FE-90	300	1,5	-	R75	SS4
Title							
Cable tray TMD - 100 - CT - 100 - 1,5 - 3 - SS2							
FLAT ELBOW 90° TMD - 100 - FE - 90 - 300 - 1,5 - R75 - SS4							

Accepted symbols:
 high loads from cables and external influences
 SS2 - stainless steel, resistance class A*
 SS4 - stainless steel, resistance class D*
 Cable tray thickness: 1.5 mm
 Cover thickness: from 50 to 200 - 1.0 mm; from 300 to 600 - 1.5 mm
 * - corrosion resistance classification according to GOST R 52868-2021



23 END CAP TMD-100-EC		
Width	SS2	SS4
100	7324933	7334933
150	7324934	7334934
200	7324935	7334935
300	7324936	7334936
400	7324937	7334937
500	7324938	7334938
600	7324939	7334939

24 REDUCER TMD-100-RP		
Width	PG	HDG
100	7323930	7333930
150	7323931	7333931
200	7323932	7333932
250	7323933	7333933
300	7323934	7333934
400	7323935	7333935

Cable ladder system LLD-60 R=300 PG/HDG

1 CABLE LADDER LLD-60-CL			2 FLAT ELBOW 90° LLD-60-FE-90			3 FLAT ELBOW 45° LLD-60-FE-45			4 FLEXI RISER LLD-60-FR			5 T-PIECE LLD-60-TE			6 X-PIECE LLD-60-XE		
Width	PG	HDG	Width	PG	HDG	Width	PG	HDG	Width	PG	HDG	Width	PG	HDG	Width	PG	HDG
100	7740601	7710601	100	7740801	7710801	100	7741001	7711001	100	7741201	7711201	100	7741301	7711301	100	7741401	7711401
200	7740602	7710602	200	7740802	7710802	200	7741002	7711002	200	7741202	7711202	200	7741302	7711302	200	7741402	7711402
300	7740603	7710603	300	7740803	7710803	300	7741003	7711003	300	7741203	7711203	300	7741303	7711303	300	7741403	7711403
400	7740604	7710604	400	7740804	7710804	400	7741004	7711004	400	7741204	7711204	400	7741304	7711304	400	7741404	7711404
500	7740605	7710605	500	7740805	7710805	500	7741005	7711005	500	7741205	7711205	500	7741305	7711305	500	7741405	7711405
600	7740606	7710606	600	7740806	7710806	600	7741006	7711006	600	7741206	7711206	600	7741306	7711306	600	7741406	7711406

7 COVER LLD-CO			8 COVER 90° LLD-CO-90			9 COVER 45° LLD-CO-45			10 COVER RISER LLD-CO-FR			11 COVER T LLD-CO-TE			12 COVER X LLD-CO-XE		
Width	PG	HDG	Width	PG	HDG	Width	PG	HDG	Width	PG	HDG	Width	PG	HDG	Width	PG	HDG
100	7742101	7712101	100	7742201	7712201	100	7743601	7713601	100	7742501	7712501	100	7742301	7712301	100	7742401	7712401
200	7742102	7712102	200	7742202	7712202	200	7743602	7713602	200	7742502	7712502	200	7742302	7712302	200	7742402	7712402
300	7742103	7712103	300	7742203	7712203	300	7743603	7713603	300	7742503	7712503	300	7742303	7712303	300	7742403	7712403
400	7742104	7712104	400	7742204	7712204	400	7743604	7713604	400	7742504	7712504	400	7742304	7712304	400	7742404	7712404
500	7742105	7712105	500	7742205	7712205	500	7743605	7713605	500	7742505	7712505	500	7742305	7712305	500	7742405	7712405
600	7742106	7712106	600	7742206	7712206	600	7743606	7713606	600	7742506	7712506	600	7742306	7712306	600	7742406	7712406

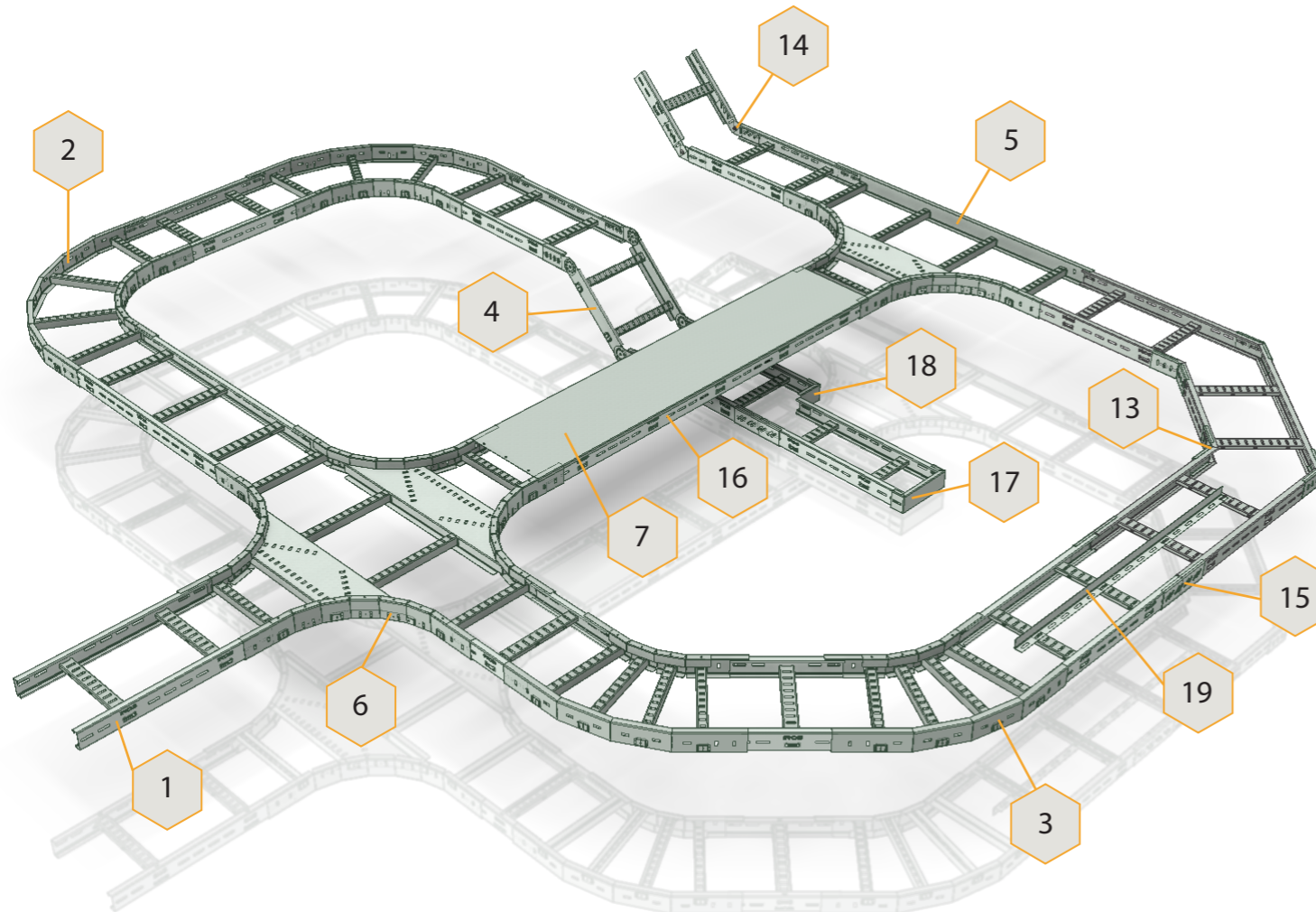

13 HINGE HORIZONTAL LLD-60-HI-G			14 HINGE VERTICAL LLD-60-HI-V		
PG	HDG		PG	HDG	
7741601	7711601		7741701	7711701	

15 SPLICE CONNECTOR LLD-60-SC			16 COVER CLAMP LLD-CO-FC		
PG	HDG		Type	PG	HDG
7741501	7711501		FC	7342601	7312601
			FC-V	-	7312605

17 END CAP LLD-60-EC			18 REDUCER LLD-60-RP		
Width	PG	HDG	Width	PG	HDG
100	7744901	7714901	100	7743901	7713901
200	7744902	7714902	200	7743902	7713902
300	7744903	7714903	300	7743903	7713903
400	7744904	7714904	400	7743904	7713904
500	7744905	7714905	500	7743905	7713905
600	7744906	7714906			

19 DIVIDER LLD-60-DI		
Type	PG	HDG
DI	7113701	7133701
DI-FR	7116201	7136201
DI-FE	7113801	7133801

Designation structure							
series	height, mm	type	width, mm	thickness, mm	length, m	radius	material
LLD	60	CL	200	1,0	3	-	PG
LLD	60	FE-90	300	1,0	-	R300	HDG
Title							
Cable ladder	LLD - 60 - CL - 200 - 1,0 - 3 - PG						
FLAT ELBOW 90°	LLD - 60 - FE - 90 - 300 - 1,0 - R300 - HDG						

Accepted symbols:
 low cable loads
 PG - pre-galvanized steel
 HDG - hot-dip galvanized steel
 Thickness of cable ladders: 1,0 mm



Cable ladder system LMD-60 R=300 HDG/SS4

1 CABLE LADDER LMD-60-CL			2 FLAT ELBOW 90° LMD-60-FE-90			3 FLAT ELBOW 45° LMD-60-FE-45			4 FLEXI RISER LMD-60-FR			5 T-PIECE LMD-60-TE			6 X-PIECE LMD-60-XE		
Width	HDG	SS4	Width	HDG	SS4	Width	HDG	SS4	Width	HDG	SS4	Width	HDG	SS4	Width	HDG	SS4
200	7110602	7130602	200	7110802	7130802	200	7111002	7131002	200	7111202	7131202	200	7111302	7131302	200	7111402	7131402
300	7110603	7130603	300	7110803	7130803	300	7111003	7131003	300	7111203	7131203	300	7111303	7131303	300	7111403	7131403
400	7110604	7130604	400	7110804	7130804	400	7111004	7131004	400	7111204	7131204	400	7111304	7131304	400	7111404	7131404
500	7110605	7130605	500	7110805	7130805	500	7111005	7131005	500	7111205	7131205	500	7111305	7131305	500	7111405	7131405
600	7110606	7130606	600	7110806	7130806	600	7111006	7131006	600	7111206	7131206	600	7111306	7131306	600	7111406	7131406

7 COVER LMD-CO			8 COVER 90° LMD-CO-90			9 COVER 45° LMD-CO-45			10 COVER RISER LMD-CO-FR			11 COVER T LMD-CO-TE			12 COVER X LMD-CO-XE		
Width	HDG	SS4	Width	HDG	SS4	Width	HDG	SS4	Width	HDG	SS4	Width	HDG	SS4	Width	HDG	SS4
200	7112108	7132108	200	7112202	7132202	200	7113602	7133602	200	7112502	7132502	200	7112302	7132302	200	7112402	7132402
300	7112109	7132109	300	7112203	7132203	300	7113603	7133603	300	7112503	7132503	300	7112303	7132303	300	7112403	7132403
400	7112110	7132110	400	7112204	7132204	400	7113604	7133604	400	7112504	7132504	400	7112304	7132304	400	7112404	7132404
500	7112111	7132111	500	7112205	7132205	500	7113605	7133605	500	7112505	7132505	500	7112305	7132305	500	7112405	7132405
600	7112112	7132112	600	7112206	7132206	600	7113606	7133606	600	7112506	7132506	600	7112306	7132306	600	7112406	7132406

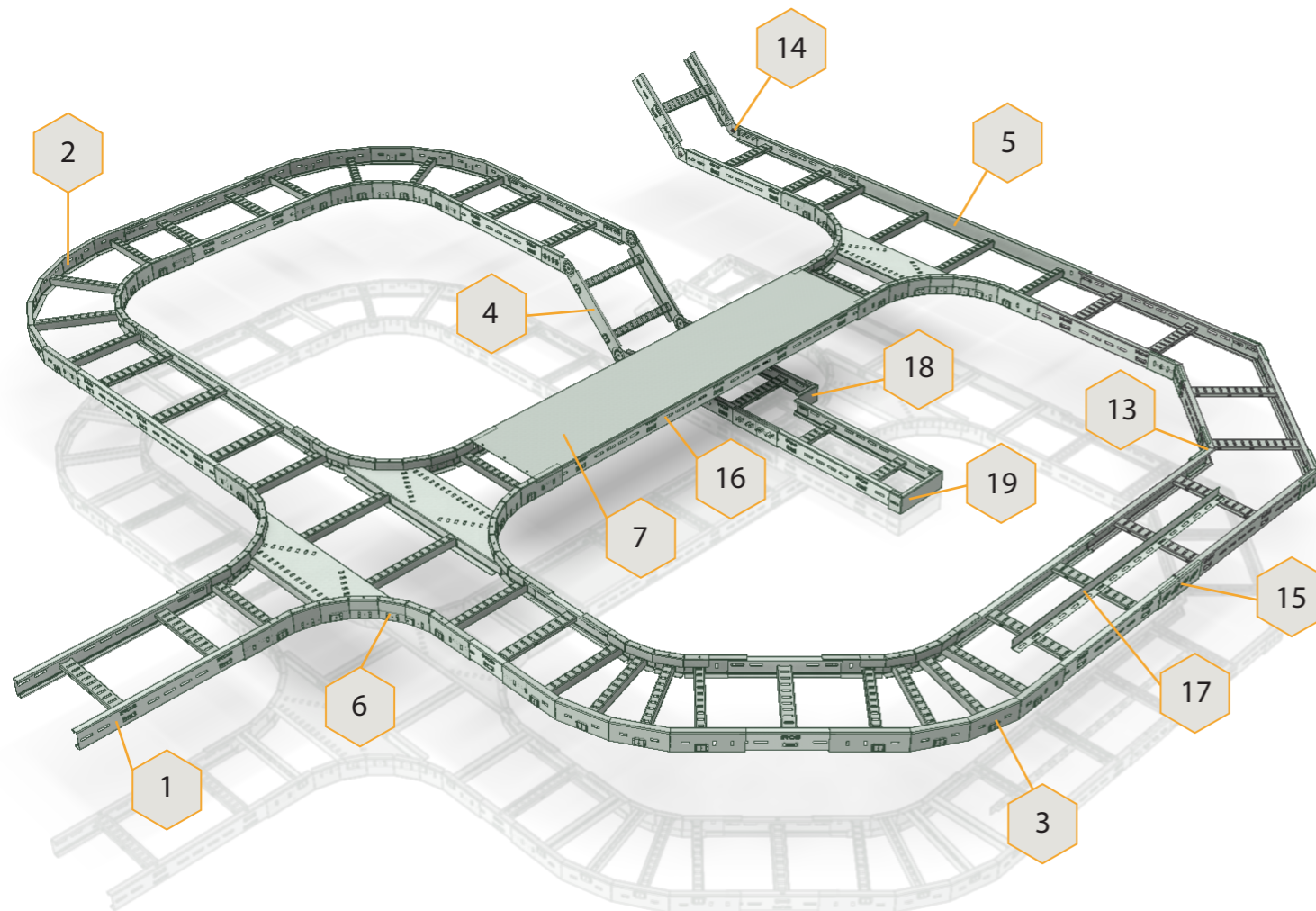
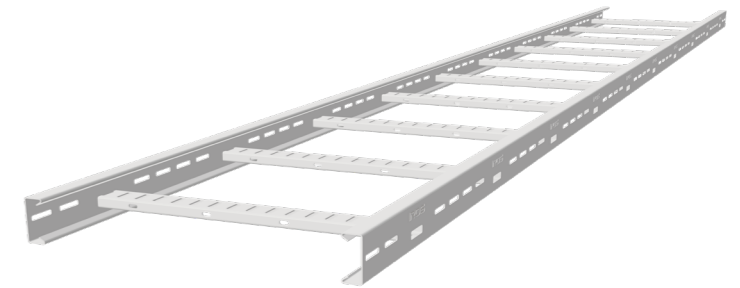

13 HINGE HORIZONTAL LMD-60-HI-G		14 HINGE VERTICAL LMD-60-HI-V	
HDG	SS4	HDG	SS4
7111601	7131601	7111701	7131701

15 SPLICE CONNECTOR LMD-60-SC		16 COVER CLAMP LMD-CO-FC		
HDG	SS4	Type	HDG	SS4
7111501	7131501	FC	7112601	7132601
		FC-V	7112604	7132604

17 DIVIDER LMD-60-DI			18 REDUCER LMD-60-RP		
Type	HDG	SS4	Width	HDG	SS4
DI	7113701	7133701	100	7113901	7133901
DI-FR	7116201	7136201	200	7113902	7133902
DI-FE	7113801	7133801	300	7113903	7133903
			400	7113904	7133904

19 END CAP LMD-60-EC			20 LIGHT BRACKET LMD-LT		
Width	HDG	SS4	Width	HDG	SS4
200	7114902	7134902	200	7112701	7132701
300	7114903	7134903	300	7112702	7132702
400	7114904	7134904	400	7112703	7132703
500	7114905	7134905	500	7112704	7132704
600	7114906	7134906	600	7112705	7132705

Designation structure							
series	height, mm	type	width, mm	thickness, mm	length, m	radius	material
LMD	60	CL	200	1,5	3	-	HDG
LMD	60	FE-90	300	1,5	-	R300	SS4
Title							
Cable ladder	LMD - 60 - CL - 200 - 1,5 - 3 - HDG						
FLAT ELBOW 90°	LMD - 60 - FE - 90 - 300 - 1,5 - R300 - SS4						

Accepted symbols:
 low cable loads
 HDG - hot-dip galvanized steel
 SS4 - stainless steel, resistance class D*
 Cable tray thickness: 1.5 mm
 * - corrosion resistance classification according to GOST R 52868-2021



Cable ladder system LMD-60 R=600 HDG/SS4

1 CABLE LADDER LMD-60-CL			2 FLAT ELBOW 90° LMD-60-FE-90			3 FLAT ELBOW 45° LMD-60-FE-45			4 FLEXI RISER LMD-60-FR			5 T-PIECE LMD-60-TE			6 X-PIECE LMD-60-XE		
Width	HDG	SS4	Width	HDG	SS4	Width	HDG	SS4	Width	HDG	SS4	Width	HDG	SS4	Width	HDG	SS4
200	7110602	7130602	200	7110820	7130820	200	7111020	7131020	200	7111220	7131220	200	7111320	7131320	200	7111420	7131420
300	7110603	7130603	300	7110821	7130821	300	7111021	7131021	300	7111221	7131221	300	7111321	7131321	300	7111421	7131421
400	7110604	7130604	400	7110822	7130822	400	7111022	7131022	400	7111222	7131222	400	7111322	7131322	400	7111422	7131422
500	7110605	7130605	500	7110823	7130823	500	7111023	7131023	500	7111223	7131223	500	7111323	7131323	500	7111423	7131423
600	7110606	7130606	600	7110824	7130824	600	7111024	7131024	600	7111224	7131224	600	7111324	7131324	600	7111424	7131424

7 COVER LMD-CO			8 COVER 90° LMD-CO-90			9 COVER 45° LMD-CO-45			10 COVER RISER LMD-CO-FR			11 COVER T LMD-CO-TE			12 COVER X LMD-CO-XE		
Width	HDG	SS4	Width	HDG	SS4	Width	HDG	SS4	Width	HDG	SS4	Width	HDG	SS4	Width	HDG	SS4
200	7112108	7132108	200	7112208	7132208	200	7113608	7133608	200	7112508	7132508	200	7112308	7132308	200	7112408	7132408
300	7112109	7132109	300	7112209	7132209	300	7113609	7133609	300	7112509	7132509	300	7112309	7132309	300	7112409	7132409
400	7112110	7132110	400	7112210	7132210	400	7113610	7133610	400	7112510	7132510	400	7112310	7132310	400	7112410	7132410
500	7112111	7132111	500	7112211	7132211	500	7113611	7133611	500	7112511	7132511	500	7112311	7132311	500	7112411	7132411
600	7112112	7132112	600	7112212	7132212	600	7113612	7133612	600	7112512	7132512	600	7112312	7132312	600	7112412	7132412

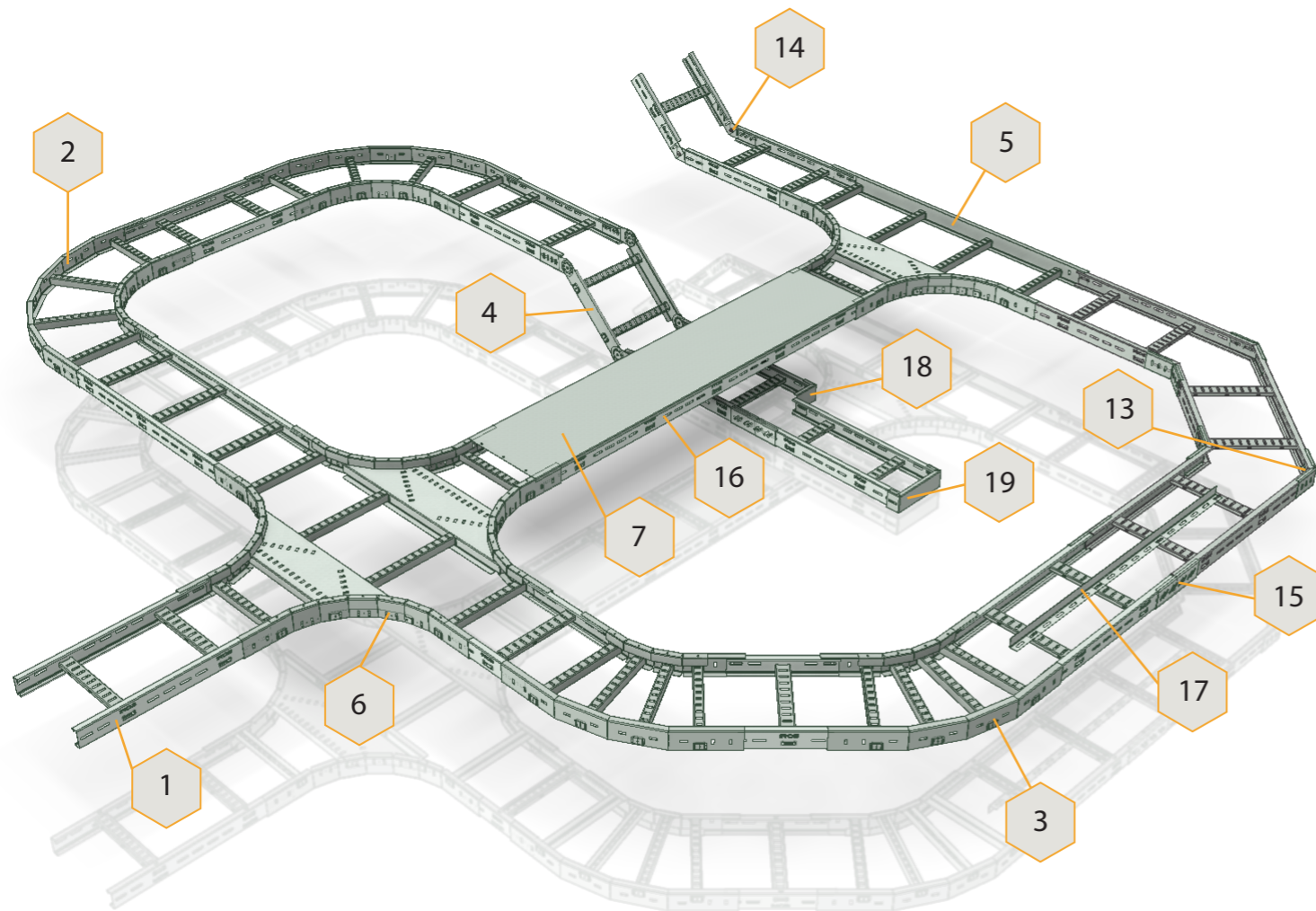
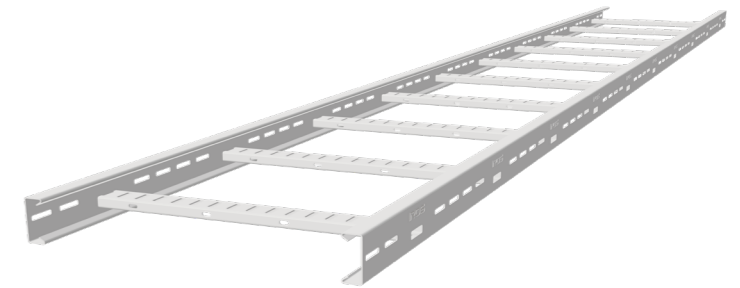

13 HINGE HORIZONTAL LMD-60-HI-G			14 HINGE VERTICAL LMD-60-HI-V		
HDG	SS4		HDG	SS4	
7111601	7131601		7111701	7131701	

15 SPLICE CONNECTOR LMD-60-SC			16 COVER CLAMP LMD-CO-FC		
HDG	SS4		Type	HDG	SS4
7111501	7131501		FC	7112601	7132601
			FC-V	7112604	7132604

17 DIVIDER LMD-60-DI			18 REDUCER LMD-60-RP		
Type	HDG	SS4	Width	HDG	SS4
DI	7113701	7133701	100	7113901	7133901
DI-FR	7116201	7136201	200	7113902	7133902
DI-FE	7113801	7133801	300	7113903	7133903
			400	7113904	7133904

19 END CAP LMD-60-EC			20 LIGHT BRACKET LMD-LT		
Width	HDG	SS4	Width	HDG	SS4
200	7114902	7134902	200	7112701	7132701
300	7114903	7134903	300	7112702	7132702
400	7114904	7134904	400	7112703	7132703
500	7114905	7134905	500	7112704	7132704
600	7114906	7134906	600	7112705	7132705

Designation structure							
series	height, mm	type	width, mm	thickness, mm	length, m	radius	material
LMD	60	CL	200	1,5	3	-	HDG
LMD	60	FE-90	300	1,5	-	R600	SS4
Title							
Cable ladder	LMD - 60 - CL - 200 - 1,5 - 3 - HDG						
FLAT ELBOW 90°	LMD - 60 - FE - 90 - 300 - 1,5 - R600 - SS4						

Accepted symbols:
 low cable loads
 HDG - hot-dip galvanized steel
 SS4 - stainless steel, resistance class D*
 Cable tray thickness: 1.5 mm
 * - corrosion resistance classification according to GOST R 52868-2021



Cable ladder system LMD-80 R=300 HDG/SS4

1 CABLE LADDER LMD-80-CL			2 FLAT ELBOW 90° LMD-80-FE-90			3 FLAT ELBOW 45° LMD-80-FE-45			4 FLEXI RISER LMD-80-FR			5 T-PIECE LMD-80-TE			6 X-PIECE LMD-80-XE		
Width	HDG	SS4	Width	HDG	SS4	Width	HDG	SS4	Width	HDG	SS4	Width	HDG	SS4	Width	HDG	SS4
200	7110608	7130608	200	7110808	7130808	200	7111008	7131008	200	7111208	7131208	200	7111308	7131308	200	7111408	7131408
300	7110609	7130609	300	7110809	7130809	300	7111009	7131009	300	7111209	7131209	300	7111309	7131309	300	7111409	7131409
400	7110610	7130610	400	7110810	7130810	400	7111010	7131010	400	7111210	7131210	400	7111310	7131310	400	7111410	7131410
500	7110611	7130611	500	7110811	7130811	500	7111011	7131011	500	7111211	7131211	500	7111311	7131311	500	7111411	7131411
600	7110612	7130612	600	7110812	7130812	600	7111012	7131012	600	7111212	7131212	600	7111312	7131312	600	7111412	7131412

7 COVER LMD-CO			8 COVER 90° LMD-CO-90			9 COVER 45° LMD-CO-45			10 COVER RISER LMD-CO-FR			11 COVER T LMD-CO-TE			12 COVER X LMD-CO-XE		
Width	HDG	SS4	Width	HDG	SS4	Width	HDG	SS4	Width	HDG	SS4	Width	HDG	SS4	Width	HDG	SS4
200	7112108	7132108	200	7112202	7132202	200	7113602	7133602	200	7112502	7132502	200	7112302	7132302	200	7112402	7132402
300	7112109	7132109	300	7112203	7132203	300	7113603	7133603	300	7112503	7132503	300	7112303	7132303	300	7112403	7132403
400	7112110	7132110	400	7112204	7132204	400	7113604	7133604	400	7112504	7132504	400	7112304	7132304	400	7112404	7132404
500	7112111	7132111	500	7112205	7132205	500	7113605	7133605	500	7112505	7132505	500	7112305	7132305	500	7112405	7132405
600	7112112	7132112	600	7112206	7132206	600	7113606	7133606	600	7112506	7132506	600	7112306	7132306	600	7112406	7132406

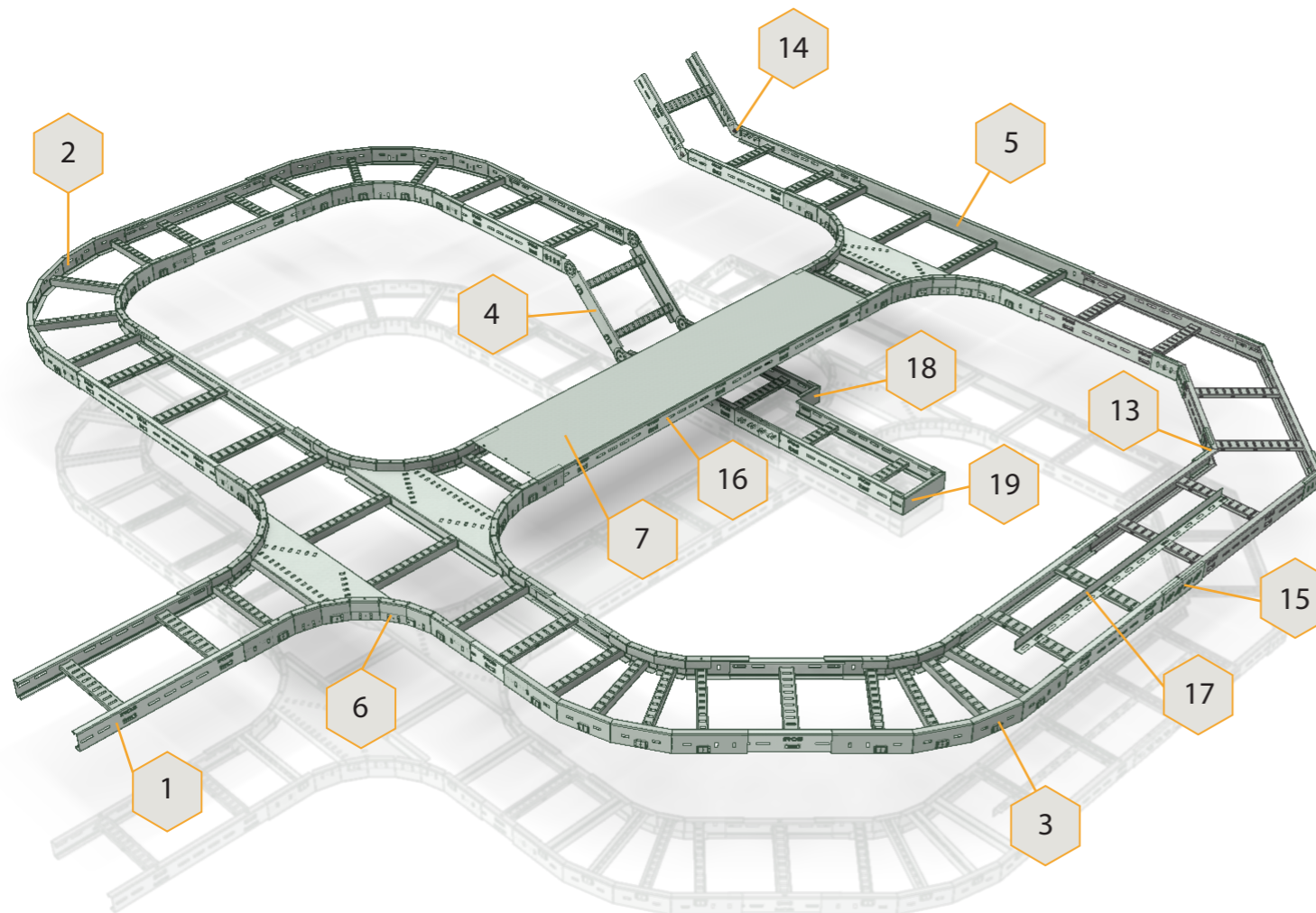
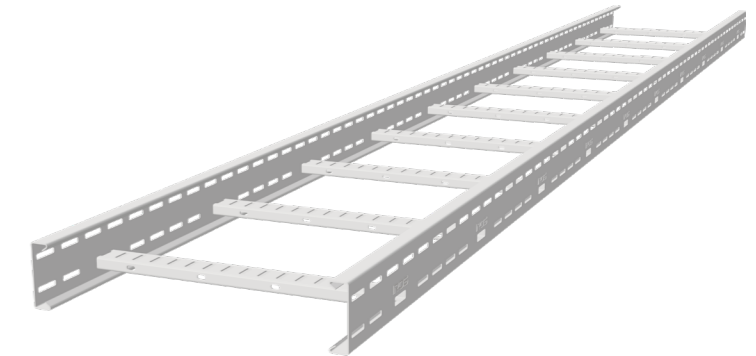

13 HINGE HORIZONTAL LMD-80-HI-G			14 HINGE VERTICAL LMD-80-HI-V		
HDG	SS4		HDG	SS4	
7111602	7131602		7111702	7131702	

15 SPLICE CONNECTOR LMD-80-SC			16 COVER CLAMP LMD-CO-FC		
HDG	SS4		Type	HDG	SS4
7111502	7131502		FC	7112601	7132601
			FC-V	7112604	7132604

17 DIVIDER LMD-80-DI			18 REDUCER LMD-80-RP		
Type	HDG	SS4	Width	HDG	SS4
DI	7113702	7133702	100	7113906	7133906
DI-FR	7116202	7136202	200	7113907	7133907
DI-FE	7113802	7133802	300	7113908	7133908
			400	7113909	7133909

19 END CAP LMD-80-EC			20 LIGHT BRACKET LMD-LT		
Width	HDG	SS4	Width	HDG	SS4
200	7114908	7134908	200	7112701	7132701
300	7114909	7134909	300	7112702	7132702
400	7114910	7134910	400	7112703	7132703
500	7114911	7134911	500	7112704	7132704
600	7114912	7134912	600	7112705	7132705

Designation structure							
series	height, mm	type	width, mm	thickness, mm	length, m	radius	material
LMD	80	CL	200	1,5	3	-	HDG
LMD	80	FE-90	300	1,5	-	R300	SS4
Title							
Cable ladder	LMD - 80 - CL - 200 - 1,5 - 3 - HDG						
FLAT ELBOW 90°	LMD - 80 - FE - 90 - 300 - 1,5 - R300 - SS4						

Accepted symbols:
 average cable loads and external influences
 HDG - hot-dip galvanized steel
 SS4 - stainless steel, resistance class D*
 Cable tray thickness: 1.5 mm
 * - corrosion resistance classification according to GOST R 52868-2021



Cable ladder system LMD-80 R=600 HDG/SS4

1 CABLE LADDER LMD-80-CL			2 FLAT ELBOW 90° LMD-80-FE-90			3 FLAT ELBOW 45° LMD-80-FE-45			4 FLEXI RISER LMD-80-FR			5 T-PIECE LMD-80-TE			6 X-PIECE LMD-80-XE		
Width	HDG	SS4	Width	HDG	SS4	Width	HDG	SS4	Width	HDG	SS4	Width	HDG	SS4	Width	HDG	SS4
200	7110608	7130608	200	7110826	7130826	200	7111026	7131026	200	7111226	7131226	200	7111326	7131326	200	7111426	7131426
300	7110609	7130609	300	7110827	7130827	300	7111027	7131027	300	7111227	7131227	300	7111327	7131327	300	7111427	7131427
400	7110610	7130610	400	7110828	7130828	400	7111028	7131028	400	7111228	7131228	400	7111328	7131328	400	7111428	7131428
500	7110611	7130611	500	7110829	7130829	500	7111029	7131029	500	7111229	7131229	500	7111329	7131329	500	7111429	7131429
600	7110612	7130612	600	7110830	7130830	600	7111030	7131030	600	7111230	7131230	600	7111330	7131330	600	7111430	7131430

7 COVER LMD-CO			8 COVER 90° LMD-CO-90			9 COVER 45° LMD-CO-45			10 COVER RISER LMD-CO-FR			11 COVER T LMD-CO-TE			12 COVER X LMD-CO-XE		
Width	HDG	SS4	Width	HDG	SS4	Width	HDG	SS4	Width	HDG	SS4	Width	HDG	SS4	Width	HDG	SS4
200	7112108	7132108	200	7112208	7132208	200	7113608	7133608	200	7112508	7132508	200	7112308	7132308	200	7112408	7132408
300	7112109	7132109	300	7112209	7132209	300	7113609	7133609	300	7112509	7132509	300	7112309	7132309	300	7112409	7132409
400	7112110	7132110	400	7112210	7132210	400	7113610	7133610	400	7112510	7132510	400	7112310	7132310	400	7112410	7132410
500	7112111	7132111	500	7112211	7132211	500	7113611	7133611	500	7112511	7132511	500	7112311	7132311	500	7112411	7132411
600	7112112	7132112	600	7112212	7132212	600	7113612	7133612	600	7112512	7132512	600	7112312	7132312	600	7112412	7132412

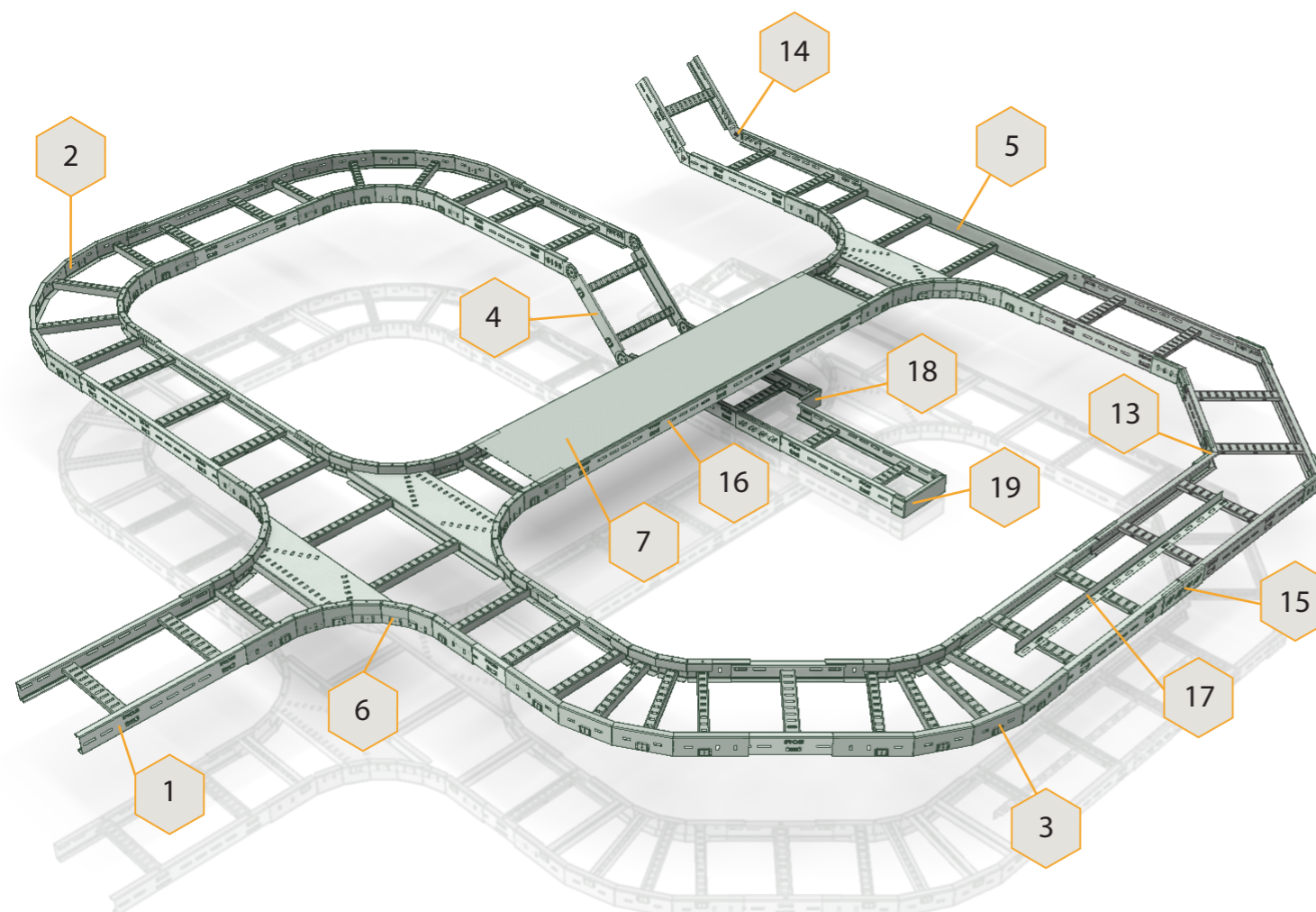
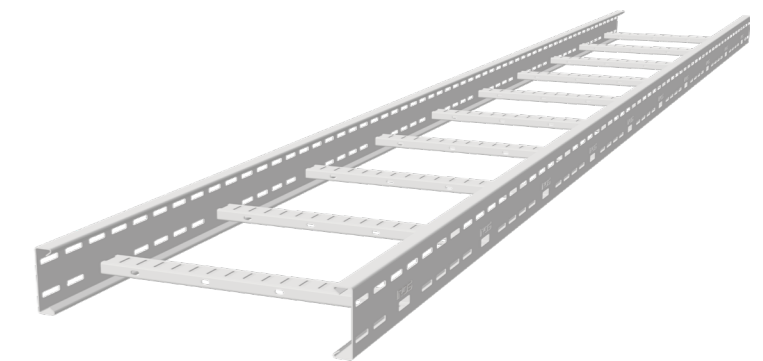

13 HINGE HORIZONTAL LMD-80-HI-G			14 HINGE VERTICAL LMD-80-HI-V		
HDG	SS4		HDG	SS4	
7111602	7131602		7111702	7131702	

15 SPLICE CONNECTOR LMD-80-SC			16 COVER CLAMP LMD-CO-FC		
HDG	SS4		Type	HDG	SS4
7111502	7131502		FC	7112601	7132601
			FC-V	7112604	7132604

17 DIVIDER LMD-80-DI			18 REDUCER LMD-80-RP		
Type	HDG	SS4	Width	HDG	SS4
DI	7113702	7133702	100	7113906	7133906
DI-FR	7116202	7136202	200	7113907	7133907
DI-FE	7113802	7133802	300	7113908	7133908
			400	7113909	7133909

19 END CAP LMD-80-EC			20 LIGHT BRACKET LMD-LT		
Width	HDG	SS4	Width	HDG	SS4
200	7114908	7134908	200	7112701	7132701
300	7114909	7134909	300	7112702	7132702
400	7114910	7134910	400	7112703	7132703
500	7114911	7134911	500	7112704	7132704
600	7114912	7134912	600	7112705	7132705

Designation structure							
series	height, mm	type	width, mm	thickness, mm	length, m	radius	material
LMD	80	CL	200	1,5	3	-	HDG
LMD	80	FE-90	300	1,5	-	R600	SS4
Title							
Cable ladder	LMD - 80 - CL - 200 - 1,5 - 3 - HDG						
FLAT ELBOW 90°	LMD - 80 - FE - 90 - 300 - 1,5 - R600 - SS4						

Accepted symbols:
 average cable loads and external influences
 HDG - hot-dip galvanized steel
 SS4 - stainless steel, resistance class D*
 Cable tray thickness: 1.5 mm
 * - corrosion resistance classification according to GOST R 52868-2021



Cable ladder system LMD-100 R=300 HDG/SS4

1 CABLE LADDER LMD-100-CL		
Width	HDG	SS4
200	7110614	7130614
300	7110615	7130615
400	7110616	7130616
500	7110617	7130617
600	7110618	7130618

2 FLAT ELBOW 90° LMD-100-FE-90		
Width	HDG	SS4
200	7110814	7130814
300	7110815	7130815
400	7110816	7130816
500	7110817	7130817
600	7110818	7130818

3 FLAT ELBOW 45° LMD-100-FE-45		
Width	HDG	SS4
200	7111014	7131014
300	7111015	7131015
400	7111016	7131016
500	7111017	7131017
600	7111018	7131018

4 FLEXI RISER LMD-100-FR		
Width	HDG	SS4
200	7111214	7131214
300	7111215	7131215
400	7111216	7131216
500	7111217	7131217
600	7111218	7131218

5 T-PIECE LMD-100-TE		
Width	HDG	SS4
200	7111314	7131314
300	7111315	7131315
400	7111316	7131316
500	7111317	7131317
600	7111318	7131318

6 X-PIECE LMD-100-XE		
Width	HDG	SS4
200	7111414	7131414
300	7111415	7131415
400	7111416	7131416
500	7111417	7131417
600	7111418	7131418

7 COVER LMD-CO		
Width	HDG	SS4
200	7112102	7132102
300	7112109	7132109
400	7112110	7132110
500	7112111	7132111
600	7112112	7132112

8 COVER 90° LMD-CO-90		
Width	HDG	SS4
300	7112203	7132203
400	7112204	7132204
500	7112205	7132205
600	7112206	7132206

9 COVER 45° LMD-CO-45		
Width	HDG	SS4
300	7113603	7133603
400	7113604	7133604
500	7113605	7133605
600	7113606	7133606

10 COVER RISER LMD-CO-FR		
Width	HDG	SS4
300	7112503	7132503
400	7112504	7132504
500	7112505	7132505
600	7112506	7132506

11 COVER T LMD-CO-TE		
Width	HDG	SS4
300	7112303	7132303
400	7112304	7132304
500	7112305	7132305
600	7112306	7132306

12 COVER X LMD-CO-XE		
Width	HDG	SS4
300	7112403	7132403
400	7112404	7132404
500	7112405	7132405
600	7112406	7132406

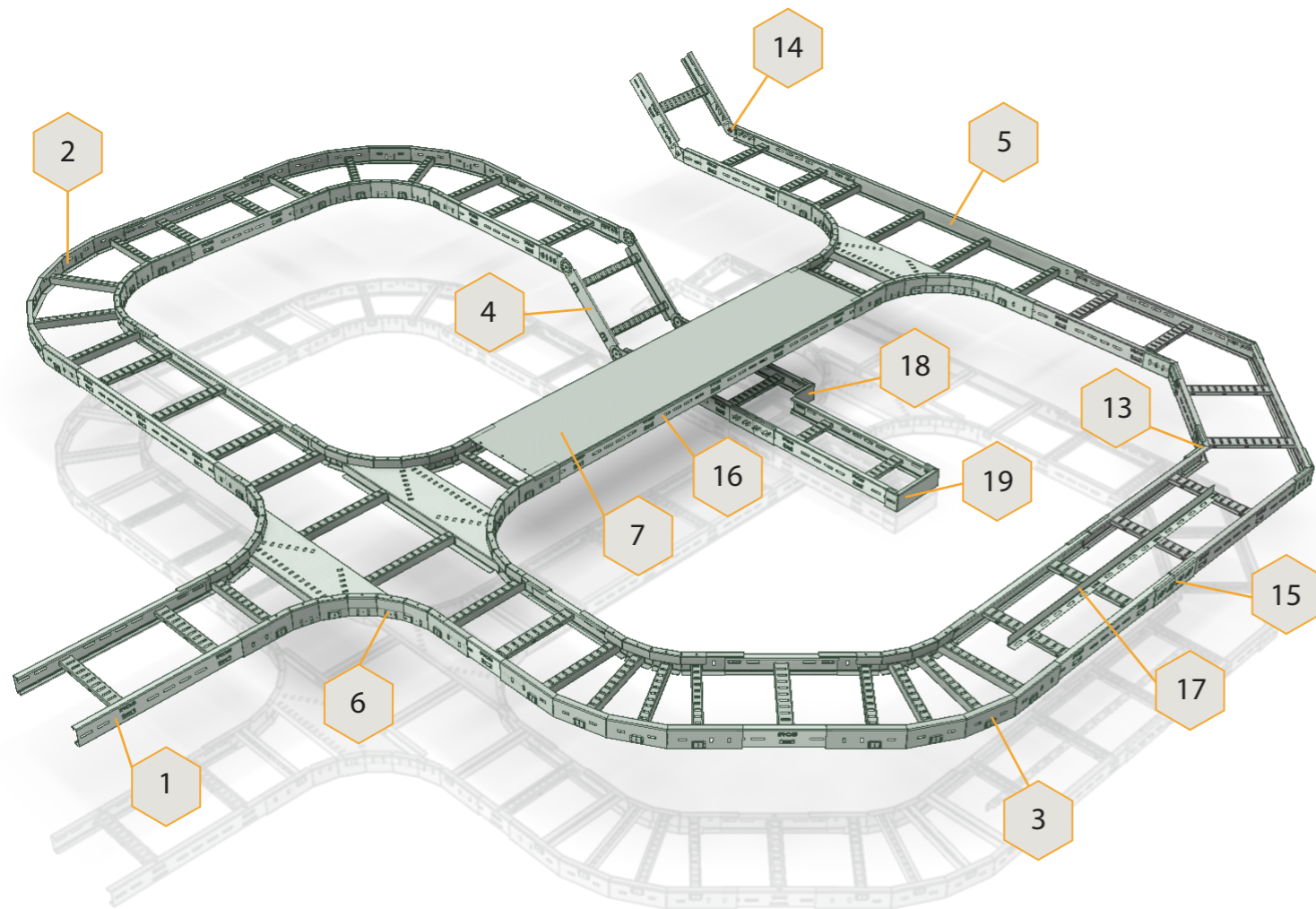
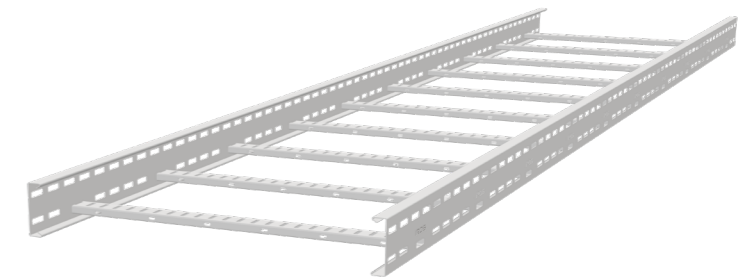

13 HINGE HORIZONTAL LMD-100-HI-G		
HDG	SS4	
7111603	7131603	

14 HINGE VERTICAL LMD-100-HI-V		
HDG	SS4	
7111703	7131703	

15 SPLICE CONNECTOR LMD-100-SC		
HDG	SS4	
7111503	7131503	

16 COVER CLAMP LMD-CO-FC		
HDG	SS4	
7112602	7132602	

17 DIVIDER LMD-100-DI		
Type	HDG	SS4
DI	7113703	7133703
DI-FR	7116203	7136203
DI-FE	7113803	7133803

18 REDUCER LMD-100-RP		
Width	HDG	SS4
100	7113911	7133911
200	7113912	7133912
300	7113913	7133913
400	7113914	7133914

19 END CAP LMD-100-EC		
Width	HDG	SS4
200	7114914	7134914
300	7114915	7134915
400	7114916	7134916
500	7114917	7134917
600	7114918	7134918

20 LIGHT BRACKET LMD-LT		
Width	HDG	SS4
200	7112701	7132701
300	7112702	7132702
400	7112703	7132703
500	7112704	7132704
600	7112705	7132705

Designation structure							
series	height, mm	type	width, mm	thickness, mm	length, m	radius	material
LMD	100	CL	200	1,5	3	-	HDG
LMD	100	FE-90	300	1,5	-	R300	SS4
Title							
Cable ladder	LMD - 100 - CL - 200 - 1,5 - 3 - HDG						
FLAT ELBOW 90°	LMD - 100 - FE - 90 - 300 - 1,5 - R300 - SS4						

Accepted symbols:
 high loads from cables and external influences
 HDG - hot-dip galvanized steel
 SS4 - stainless steel, resistance class D*
 Cable tray thickness: 1.5 mm
 * - corrosion resistance classification according to GOST R 52868-2021



Cable ladder system LMD-100 R=600 HDG/SS4

1 CABLE LADDER LMD-100-CL		
Width	HDG	SS4
200	7110614	7130614
300	7110615	7130615
400	7110616	7130616
500	7110617	7130617
600	7110618	7130618

2 FLAT ELBOW 90° LMD-100-FE-90		
Width	HDG	SS4
200	7110832	7130832
300	7110833	7130833
400	7110834	7130834
500	7110835	7130835
600	7110836	7130836

3 FLAT ELBOW 45° LMD-100-FE-45		
Width	HDG	SS4
200	7111032	7131032
300	7111033	7131033
400	7111034	7131034
500	7111035	7131035
600	7111036	7131036

4 FLEXI RISER LMD-100-FR		
Width	HDG	SS4
200	7111232	7131232
300	7111233	7131233
400	7111234	7131234
500	7111235	7131235
600	7111236	7131236

5 T-PIECE LMD-100-TE		
Width	HDG	SS4
200	7111332	7131332
300	7111333	7131333
400	7111334	7131334
500	7111335	7131335
600	7111336	7131336

6 X-PIECE LMD-100-XE		
Width	HDG	SS4
200	7111432	7131432
300	7111433	7131433
400	7111434	7131434
500	7111435	7131435
600	7111436	7131436

7 COVER LMD-CO		
Width	HDG	SS4
200	7112108	7132108
300	7112109	7132109
400	7112110	7132110
500	7112111	7132111
600	7112112	7132112

8 COVER 90° LMD-CO-90		
Width	HDG	SS4
300	7112209	7132209
400	7112210	7132210
500	7112211	7132211
600	7112212	7132212

9 COVER 45° LMD-CO-45		
Width	HDG	SS4
300	7113609	7133609
400	7113610	7133610
500	7113611	7133611
600	7113612	7133612

10 COVER RISER LMD-CO-FR		
Width	HDG	SS4
300	7112509	7132509
400	7112510	7132510
500	7112511	7132511
600	7112512	7132512

11 COVER T LMD-CO-TE		
Width	HDG	SS4
300	7112309	7132309
400	7112310	7132310
500	7112311	7132311
600	7112312	7132312

12 COVER X LMD-CO-XE		
Width	HDG	SS4
300	7112409	7132409
400	7112410	7132410
500	7112411	7132411
600	7112412	7132412

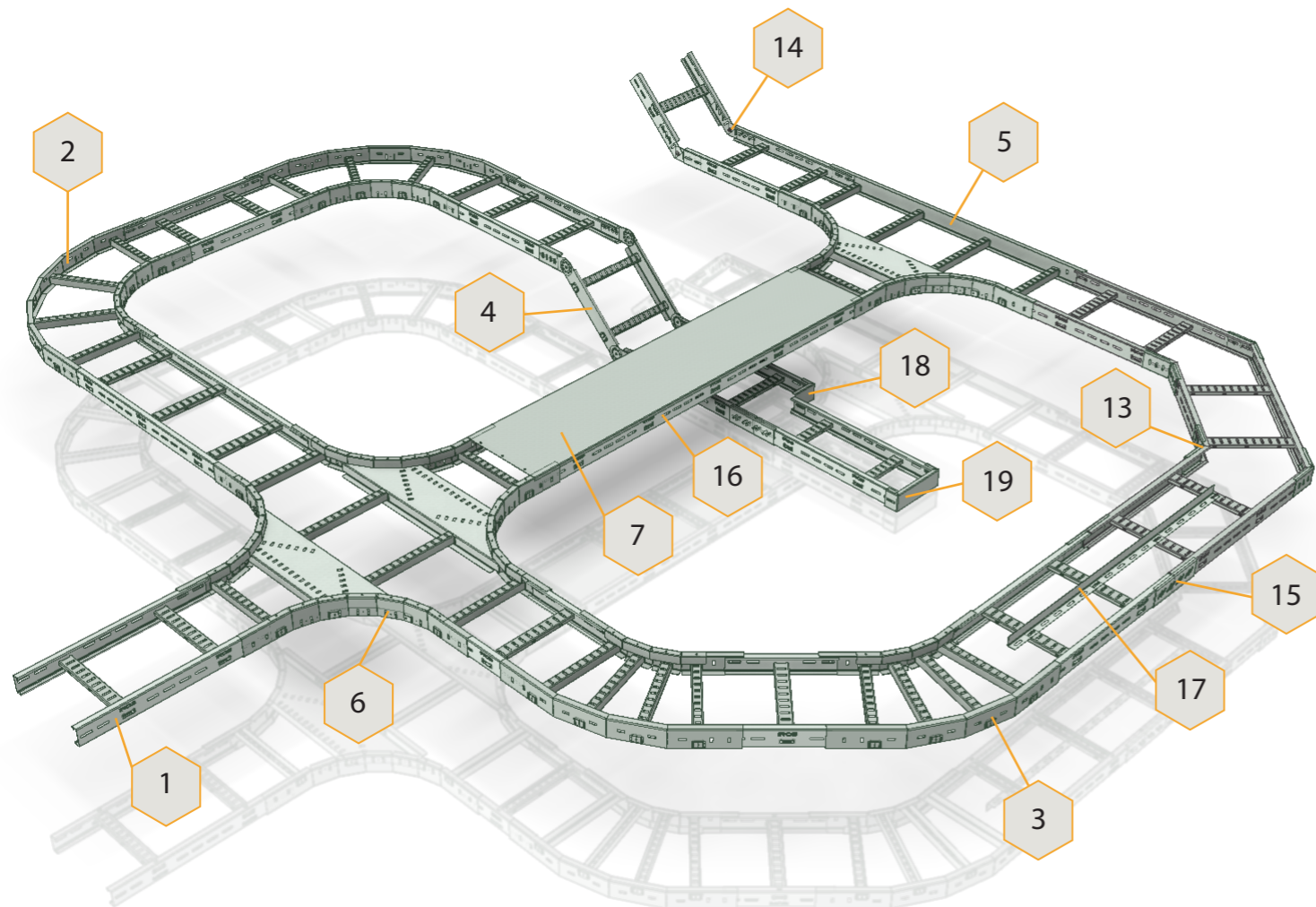
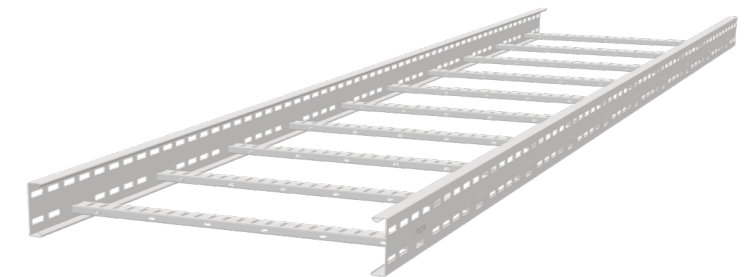

13 HINGE HORIZONTAL LMD-100-HI-G		
HDG	SS4	
7111603	7131603	

14 HINGE VERTICAL LMD-100-HI-V		
HDG	SS4	
7111703	7131703	

15 SPLICE CONNECTOR LMD-80-SC		
HDG	SS4	
7111503	7131503	

16 COVER CLAMP LMD-CO-FC		
HDG	SS4	
7112602	7132602	

17 DIVIDER LMD-100-DI		
Type	HDG	SS4
DI	7113703	7133703
DI-FE	7113803	7133803
DI-FR	7116203	7136203

18 REDUCER LMD-100-RP		
Width	HDG	SS4
100	7113911	7133911
200	7113912	7133912
300	7113913	7133913
400	7113914	7133914

19 END CAP LMD-100-EC		
Width	HDG	SS4
200	7114914	7134914
300	7114915	7134915
400	7114916	7134916
500	7114917	7134917
600	7114918	7134918

20 LIGHT BRACKET LMD-LT		
Width	HDG	SS4
200	7112701	7132701
300	7112702	7132702
400	7112703	7132703
500	7112704	7132704
600	7112705	7132705

Designation structure							
series	height, mm	type	width, mm	thickness, mm	length, m	radius	material
LMD	100	CL	200	1,5	3	-	HDG
LMD	100	FE-90	300	1,5	-	R600	SS4
Title							
Cable ladder	LMD - 100 - CL - 200 - 1,5 - 3 - HDG						
FLAT ELBOW 90°	LMD - 100 - FE - 90 - 300 - 1,5 - R600 - SS4						

Accepted symbols:
 high loads from cables and external influences
 HDG - hot-dip galvanized steel
 SS4 - stainless steel, resistance class D*
 Cable tray thickness: 1.5 mm
 * - corrosion resistance classification according to GOST R 52868-2021



Cable ladder system LHD-100 R=300 HDG/SS4

1 CABLE LADDER LHD-100-CL		
Width	HDG	SS4
150	7210601	7230601
300	7210602	7230602
450	7210603	7230603
500	7210604	7230604
600	7210605	7230605
700	7210606	7230606
750	7210607	7230607
800	7210608	7230608
900	7210609	7230609

2 FLAT ELBOW 90° LHD-100-FE-90		
Width	HDG	SS4
150	7210801	7230801
300	7210802	7230802
450	7210803	7230803
500	7210804	7230804
600	7210805	7230805
700	7210806	7230806
750	7210807	7230807
800	7210808	7230808
900	7210809	7230809

3 FLAT ELBOW 60° LHD-100-FE-60		
Width	HDG	SS4
150	7210901	7230901
300	7210902	7230902
450	7210903	7230903
500	7210904	7230904
600	7210905	7230905
700	7210906	7230906
750	7210907	7230907
800	7210908	7230908
900	7210909	7230909

4 FLAT ELBOW 45° LHD-100-FE-45		
Width	HDG	SS4
150	7211001	7231001
300	7211002	7231002
450	7211003	7231003
500	7211004	7231004
600	7211005	7231005
700	7211006	7231006
750	7211007	7231007
800	7211008	7231008
900	7211009	7231009

5 FLAT ELBOW 30° LHD-100-FE-30		
Width	HDG	SS4
150	7211101	7231101
300	7211102	7231102
450	7211103	7231103
500	7211104	7231104
600	7211105	7231105
700	7211106	7231106
750	7211107	7231107
800	7211108	7231108
900	7211109	7231109

6 FLEXI RISER LHD-100-FR		
Width	HDG	SS4
150	7211201	7231201
300	7211202	7231202
450	7211203	7231203
500	7211204	7231204
600	7211205	7231205
700	7211206	7231206
750	7211207	7231207
800	7211208	7231208
900	7211209	7231209

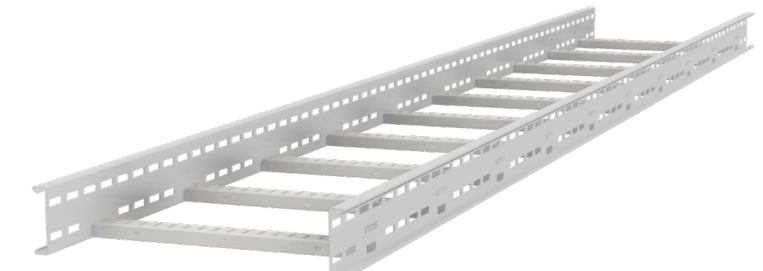

7 COVER LHD-CO		
Width	HDG	SS4
150	7212104	7232104
300	7212105	7232105
450	7212106	7232106
500	7212107	7232107
600	7212108	7232108
700	7212109	7232109
750	7212110	7232110
800	7212111	7232111
900	7212112	7232112

8 COVER 90° LHD-CO-FE-90		
Width	HDG	SS4
150	7212201	7232201
300	7212202	7232202
450	7212203	7232203
500	7212204	7232204
600	7212205	7232205
700	7212206	7232206
750	7212207	7232207
800	7212208	7232208
900	7212209	7232209

9 COVER 60° LHD-CO-FE-60		
Width	HDG	SS4
150	7214201	7234201
300	7214202	7234202
450	7214203	7234203
500	7214204	7234204
600	7214205	7234205
700	7214206	7234206
750	7214207	7234207
800	7214208	7234208
900	7214209	7234209

10 COVER 45° LHD-CO-FE-45		
Width	HDG	SS4
150	7213601	7233601
300	7213602	7233602
450	7213603	7233603
500	7213604	7233604
600	7213605	7233605
700	7213606	7233606
750	7213607	7233607
800	7213608	7233608
900	7213609	7233609

11 COVER 30° LHD-CO-FE-30		
Width	HDG	SS4
150	7216101	7236101
300	7216102	7236102
450	7216103	7236103
500	7216104	7236104
600	7216105	7236105
700	7216106	7236106
750	7216107	7236107
800	7216108	7236108
900	7216109	7236109

12 COVER RISER LHD-CO-FR		
Width	HDG	SS4
150	7212501	7232501
300	7212502	7232502
450	7212503	7232503
500	7212504	7232504
600	7212505	7232505
700	7212506	7232506
750	7212507	7232507
800	7212508	7232508
900	7212509	7232509

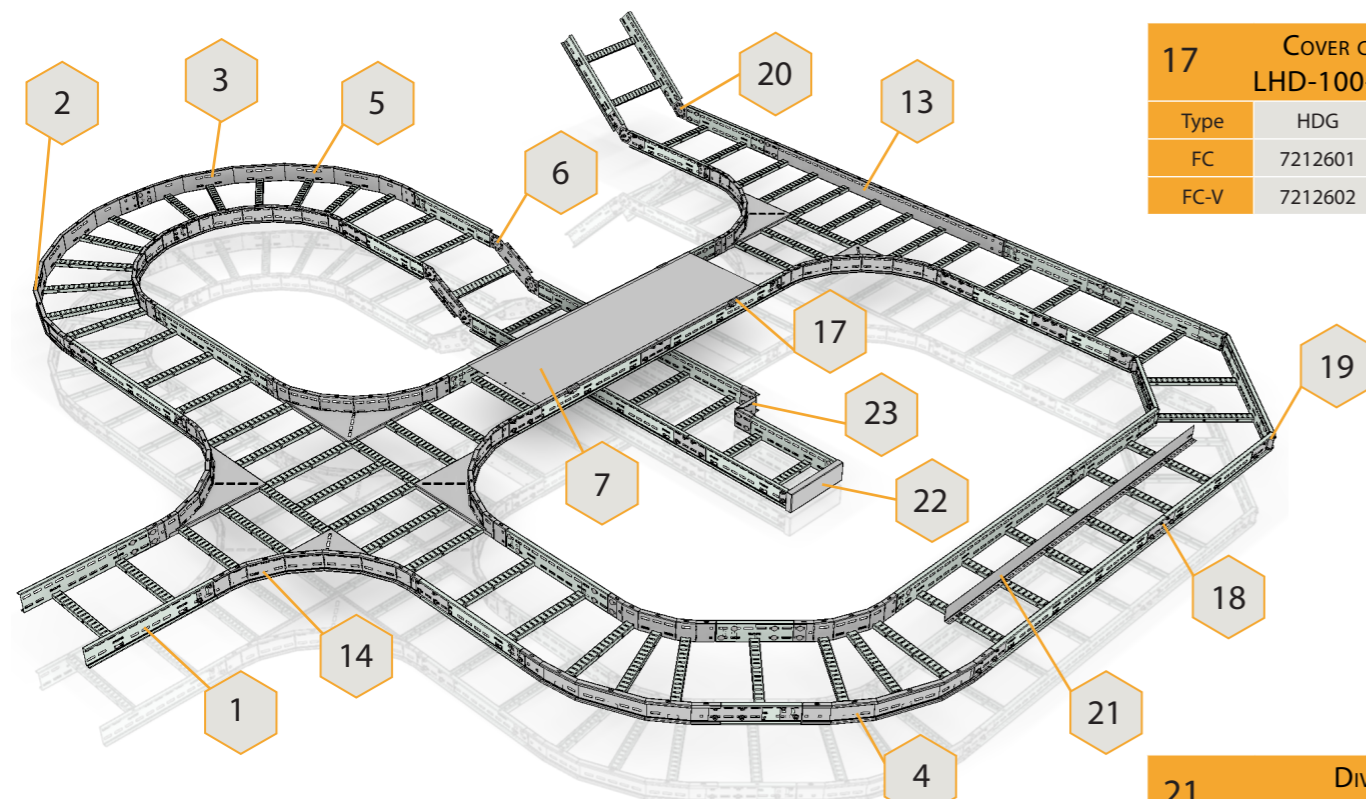

17 COVER CLAMP LHD-100-CO-FC		
Type	HDG	SS4
FC	7212601	7232601
FC-V	7212602	7232602

13 T-PIECE LHD-100-TE		
Width	HDG	SS4
150	7211301	7231301
300	7211302	7231302
450	7211303	7231303
500	7211304	7231304
600	7211305	7231305
700	7211306	7231306
750	7211307	7231307
800	7211308	7231308
900	7211309	7231309

14 X-PIECE LHD-100-XE		
Width	HDG	SS4
150	7211401	7231401
300	7211402	7231402
450	7211403	7231403
500	7211404	7231404
600	7211405	7231405
700	7211406	7231406
750	7211407	7231407
800	7211408	7231408
900	7211409	7231409

18 SPLICE CONNECTOR LHD-100-SC		
HDG	SS4	
7211501	7231501	

19 HINGE HORIZONTAL LHD-100-HI-G		
HDG	SS4	
7211601	7231601	

20 HINGE VERTICAL LHD-100-HI-V		
HDG	SS4	
7211701	7231701	

21 DIVIDER LHD-100-DI		
Type	HDG	SS4
DI	7113701	7133701
DI-FE	7113801	7133801
DI-FR	7116201	7136201

15 COVER T LHD-CO-TE		
Width	HDG	SS4
150	7212301	7232301
300	7212302	7232302
450	7212303	7232303
500	7212304	7232304
600	7212305	7232305
700	7212306	7232306
750	7212307	7232307
800	7212308	7232308
900	7212309	7232309

16 COVER X LHD-CO-XE		
Width	HDG	SS4
150	7212401	7232401
300	7212402	7232402
450	7212403	7232403
500	7212404	7232404
600	7212405	7232405
700	7212406	7232406
750	7212407	7232407
800	7212408	7232408
900	7212409	7232409

22 END CAP LHD-100-EC		
Width	HDG	SS4
150	7214901	7234901
300	7214902	7234902
450	7214903	7234903
500	7214904	7234904
600	7214905	7234905
700	7214906	7234906
750	7214907	7234907
800	7214908	7234908
900	7214909	7234909

23 REDUCER LHD-100-RP		
Width	HDG	SS4
100	7213901	7233901
150	7213902	7233902
300	7213903	7233903
450	7213904	7233904
500	7213905	7233905
600	7213906	7233906
750	7213907	7233907

Designation structure							
series	height, mm	type	width, mm	thickness, mm	length, m	radius	material
LHD	100	CL	150	1,5	3	-	HDG
LHD	100	FE-90	300	1,5	-	R300	SS4
Title							
Cable ladder		LHD - 100 - CL - 150 - 1,5 - 3 - HDG					
FLAT ELBOW 90°		LHD - 100 - FE - 90 - 300 - 1,5 - R300 - SS4					

Accepted symbols:
 high loads from cables and external influences
 HDG - hot-dip galvanized steel
 SS4 - stainless steel, resistance class D*
 * - corrosion resistance classification according to GOST R 52868-20211
 Note:
 Cable tray thickness 2 mm available on request



Cable ladder system LHD-100 R=600 HDG/SS4

1 CABLE LADDER LHD-100-CL		
Width	HDG	SS4
150	7210601	7230601
300	7210602	7230602
450	7210603	7230603
500	7210604	7230604
600	7210605	7230605
700	7210606	7230606
750	7210607	7230607
800	7210608	7230608
900	7210609	7230609

2 FLAT ELBOW 90° LHD-100-FE-90		
Width	HDG	SS4
150	7210828	7230828
300	7210829	7230829
450	7210830	7230830
500	7210831	7230831
600	7210832	7230832
700	7210833	7230833
750	7210834	7230834
800	7210835	7230835
900	7210836	7230836

3 FLAT ELBOW 60° LHD-100-FE-60		
Width	HDG	SS4
150	7210928	7230928
300	7210929	7230929
450	7210930	7230930
500	7210931	7230931
600	7210932	7230932
700	7210933	7230933
750	7210934	7230934
800	7210935	7230935
900	7210936	7230936

4 FLAT ELBOW 45° LHD-100-FE-45		
Width	HDG	SS4
150	7211028	7231028
300	7211029	7231029
450	7211030	7231030
500	7211031	7231031
600	7211032	7231032
700	7211033	7231033
750	7211034	7231034
800	7211035	7231035
900	7211036	7231036

5 FLAT ELBOW 30° LHD-100-FE-30		
Width	HDG	SS4
150	7211128	7231128
300	7211129	7231129
450	7211130	7231130
500	7211131	7231131
600	7211132	7231132
700	7211133	7231133
750	7211134	7231134
800	7211135	7231135
900	7211136	7231136

6 FLEXI RISER LHD-100-FR		
Width	HDG	SS4
150	7211228	7231228
300	7211229	7231229
450	7211230	7231230
500	7211231	7231231
600	7211232	7231232
700	7211233	7231233
750	7211234	7231234
800	7211235	7231235
900	7211236	7231236

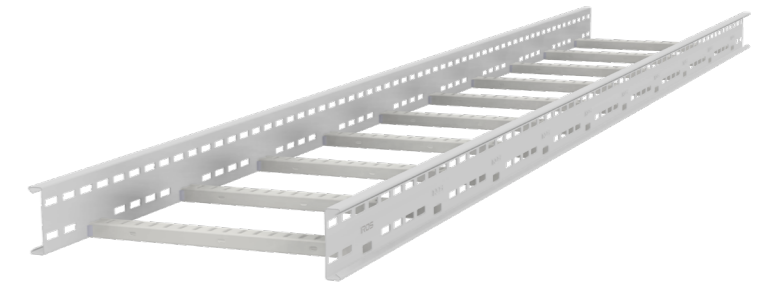

7 COVER LHD-CO		
Width	HDG	SS4
150	7212104	7232104
300	7212105	7232105
450	7212106	7232106
500	7212107	7232107
600	7212108	7232108
700	7212109	7232109
750	7212110	7232110
800	7212111	7232111
900	7212112	7232112

8 COVER 90° LHD-CO-FE-90		
Width	HDG	SS4
150	7212210	7232210
300	7212211	7232211
450	7212212	7232212
500	7212213	7232213
600	7212214	7232214
700	7212215	7232215
750	7212216	7232216
800	7212217	7232217
900	7212218	7232218

9 COVER 60° LHD-CO-FE-60		
Width	HDG	SS4
150	7214210	7234210
300	7214211	7234211
450	7214212	7234212
500	7214213	7234213
600	7214214	7234214
700	7214215	7234215
750	7214216	7234216
800	7214217	7234217
900	7214218	7234218

10 COVER 45° LHD-CO-FE-45		
Width	HDG	SS4
150	7213610	7233610
300	7213611	7233611
450	7213612	7233612
500	7213613	7233613
600	7213614	7233614
700	7213615	7233615
750	7213616	7233616
800	7213617	7233617
900	7213618	7233618

11 COVER 30° LHD-CO-FE-30		
Width	HDG	SS4
150	7216110	7236110
300	7216111	7236111
450	7216112	7236112
500	7216113	7236113
600	7216114	7236114
700	7216115	7236115
750	7216116	7236116
800	7216117	7236117
900	7216118	7236118

12 COVER RISER LHD-CO-FR		
Width	HDG	SS4
150	7212510	7232510
300	7212511	7232511
450	7212512	7232512
500	7212513	7232513
600	7212514	7232514
700	7212515	7232515
750	7212516	7232516
800	7212517	7232517
900	7212518	7232518

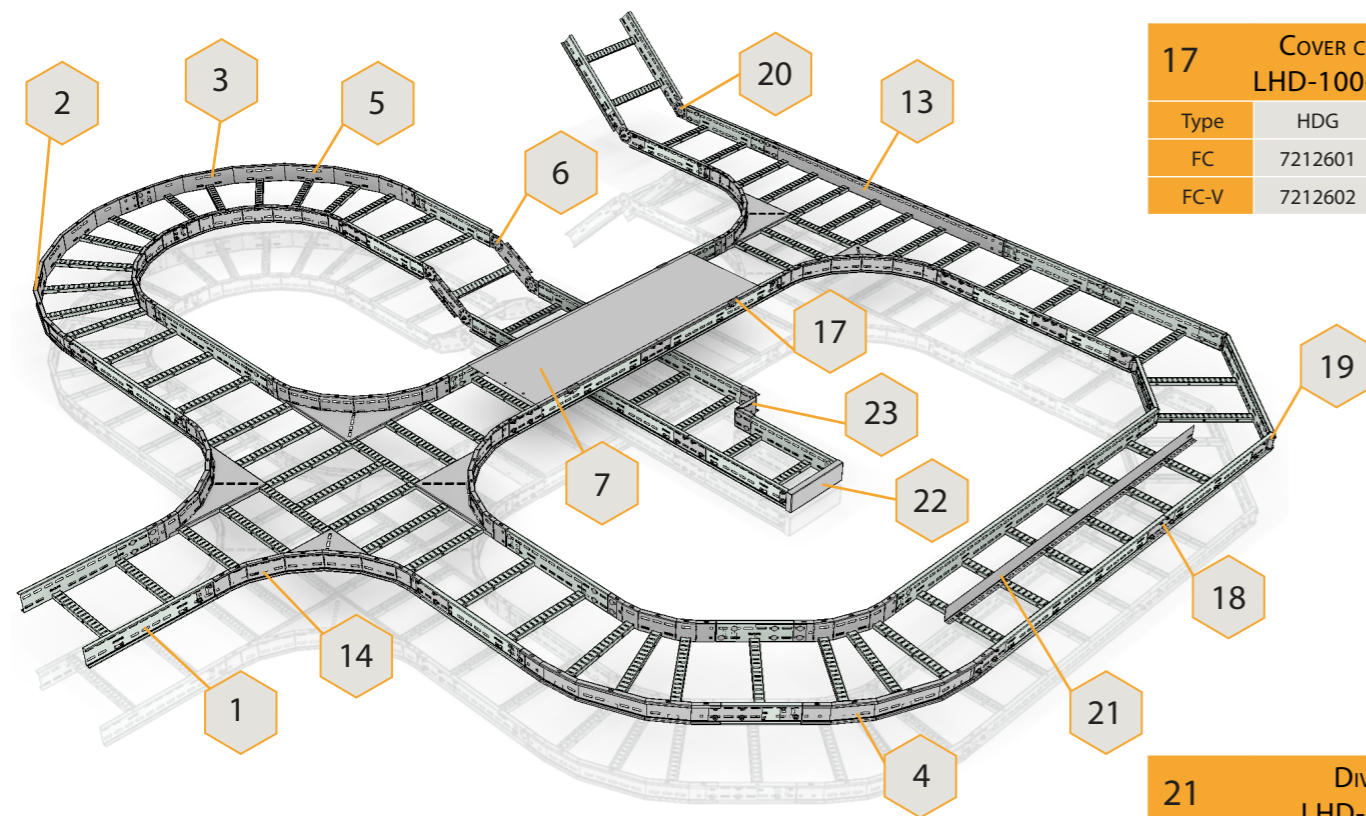

17 COVER CLAMP LHD-100-CO-FC		
Type	HDG	SS4
FC	7212601	7232601
FC-V	7212602	7232602

13 T-PIECE LHD-100-TE		
Width	HDG	SS4
150	7211328	7231328
300	7211329	7231329
450	7211330	7231330
500	7211331	7231331
600	7211332	7231332
700	7211333	7231333
750	7211334	7231334
800	7211335	7231335
900	7211336	7231336

14 X-PIECE LHD-100-XE		
Width	HDG	SS4
150	7211428	7231428
300	7211429	7231429
450	7211430	7231430
500	7211431	7231431
600	7211432	7231432
700	7211433	7231433
750	7211434	7231434
800	7211435	7231435
900	7211436	7231436

18 SPLICE CONNECTOR LHD-100-SC		
HDG	SS4	
7211501	7231501	

19 HINGE HORIZONTAL LHD-100-HI-G		
HDG	SS4	
7211601	7231601	

20 HINGE VERTICAL LHD-100-HI-V		
HDG	SS4	
7211701	7231701	

21 DIVIDER LHD-100-DI		
Type	HDG	SS4
DI	7113701	7133701
DI-FE	7113801	7133801
DI-FR	7116201	7136201

15 COVER T LHD-CO-TE		
Width	HDG	SS4
150	7212310	7232310
300	7212311	7232311
450	7212312	7232312
500	7212313	7232313
600	7212314	7232314
700	7212315	7232315
750	7212316	7232316
800	7212317	7232317
900	7212318	7232318

16 COVER X LHD-CO-XE		
Width	HDG	SS4
150	7212410	7232410
300	7212411	7232411
450	7212412	7232412
500	7212413	7232413
600	7212414	7232414
700	7212415	7232415
750	7212416	7232416
800	7212417	7232417
900	7212418	7232418

22 END CAP LHD-100-EC		
Width	HDG	SS4
150	7214901	7234901
300	7214902	7234902
450	7214903	7234903
500	7214904	7234904
600	7214905	7234905
700	7214906	7234906
750	7214907	7234907
800	7214908	7234908
900	7214909	7234909

23 REDUCER LHD-100-RP		
Width	HDG	SS4
100	7213901	7233901
150	7213902	7233902
300	7213903	7233903
450	7213904	7233904
500	7213905	7233905
600	7213906	7233906
750	7213907	7233907

Designation structure							
series	height, mm	type	width, mm	thickness, mm	length, m	radius	material
LHD	100	CL	150	1,5	3	-	HDG
LHD	100	FE-90	300	1,5	-	R600	SS4
Title							
Cable ladder LHD - 100 - CL - 150 - 1,5 - 3 - HDG							
FLAT ELBOW 90° LHD - 100 - FE - 90 - 300 - 1,5 - R600 - SS4							

Accepted symbols:
 high loads from cables and external influences
 HDG - hot-dip galvanized steel
 SS4 - stainless steel, resistance class D*
 * - corrosion resistance classification according to GOST R 52868-20211
 Note:
 Cable tray thickness 2 mm available on request



Cable ladder system LHD-100 R=900 HDG/SS4

1 CABLE LADDER LHD-100-CL		
Width	HDG	SS4
150	7210601	7230601
300	7210602	7230602
450	7210603	7230603
500	7210604	7230604
600	7210605	7230605
700	7210606	7230606
750	7210607	7230607
800	7210608	7230608
900	7210609	7230609

2 FLAT ELBOW 90° LHD-100-FE-90		
Width	HDG	SS4
150	7210855	7230855
300	7210856	7230856
450	7210857	7230857
500	7210858	7230858
600	7210859	7230859
700	7210860	7230860
750	7210861	7230861
800	7210862	7230862
900	7210863	7230863

3 FLAT ELBOW 60° LHD-100-FE-60		
Width	HDG	SS4
150	7210955	7230955
300	7210956	7230956
450	7210957	7230957
500	7210958	7230958
600	7210959	7230959
700	7210960	7230960
750	7210961	7230961
800	7210962	7230962
900	7210963	7230963

4 FLAT ELBOW 45° LHD-100-FE-45		
Width	HDG	SS4
150	7211055	7231055
300	7211056	7231056
450	7211057	7231057
500	7211058	7231058
600	7211059	7231059
700	7211060	7231060
750	7211061	7231061
800	7211062	7231062
900	7211063	7231063

5 FLAT ELBOW 30° LHD-100-FE-30		
Width	HDG	SS4
150	7211155	7231155
300	7211156	7231156
450	7211157	7231157
500	7211158	7231158
600	7211159	7231159
700	7211160	7231160
750	7211161	7231161
800	7211162	7231162
900	7211163	7231163

6 FLEXI RISER LHD-100-FR		
Width	HDG	SS4
150	7211255	7231255
300	7211256	7231256
450	7211257	7231257
500	7211258	7231258
600	7211259	7231259
700	7211260	7231260
750	7211261	7231261
800	7211262	7231262
900	7211263	7231263

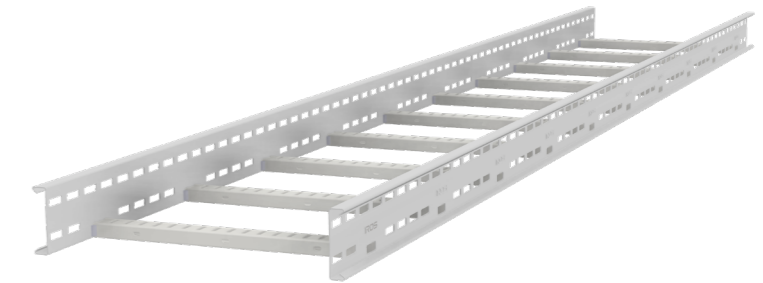

7 COVER LHD-CO		
Width	HDG	SS4
150	7212104	7232104
300	7212105	7232105
450	7212106	7232106
500	7212107	7232107
600	7212108	7232108
700	7212109	7232109
750	7212110	7232110
800	7212111	7232111
900	7212112	7232112

8 COVER 90° LHD-CO-FE-90		
Width	HDG	SS4
150	7212219	7232219
300	7212220	7232220
450	7212221	7232221
500	7212222	7232222
600	7212223	7232223
700	7212224	7232224
750	7212225	7232225
800	7212226	7232226
900	7212227	7232227

9 COVER 60° LHD-CO-FE-60		
Width	HDG	SS4
150	7214219	7234219
300	7214220	7234220
450	7214221	7234221
500	7214222	7234222
600	7214223	7234223
700	7214224	7234224
750	7214225	7234225
800	7214226	7234226
900	7214227	7234227

10 COVER 45° LHD-CO-FE-45		
Width	HDG	SS4
150	7213619	7233619
300	7213620	7233620
450	7213621	7233621
500	7213622	7233622
600	7213623	7233623
700	7213624	7233624
750	7213625	7233625
800	7213626	7233626
900	7213627	7233627

11 COVER 30° LHD-CO-FE-30		
Width	HDG	SS4
150	7216119	7236119
300	7216120	7236120
450	7216121	7236121
500	7216122	7236122
600	7216123	7236123
700	7216124	7236124
750	7216125	7236125
800	7216126	7236126
900	7216127	7236127

12 COVER RISER LHD-CO-FR		
Width	HDG	SS4
150	7212519	7232519
300	7212520	7232520
450	7212521	7232521
500	7212522	7232522
600	7212523	7232523
700	7212524	7232524
750	7212525	7232525
800	7212526	7232526
900	7212527	7232527

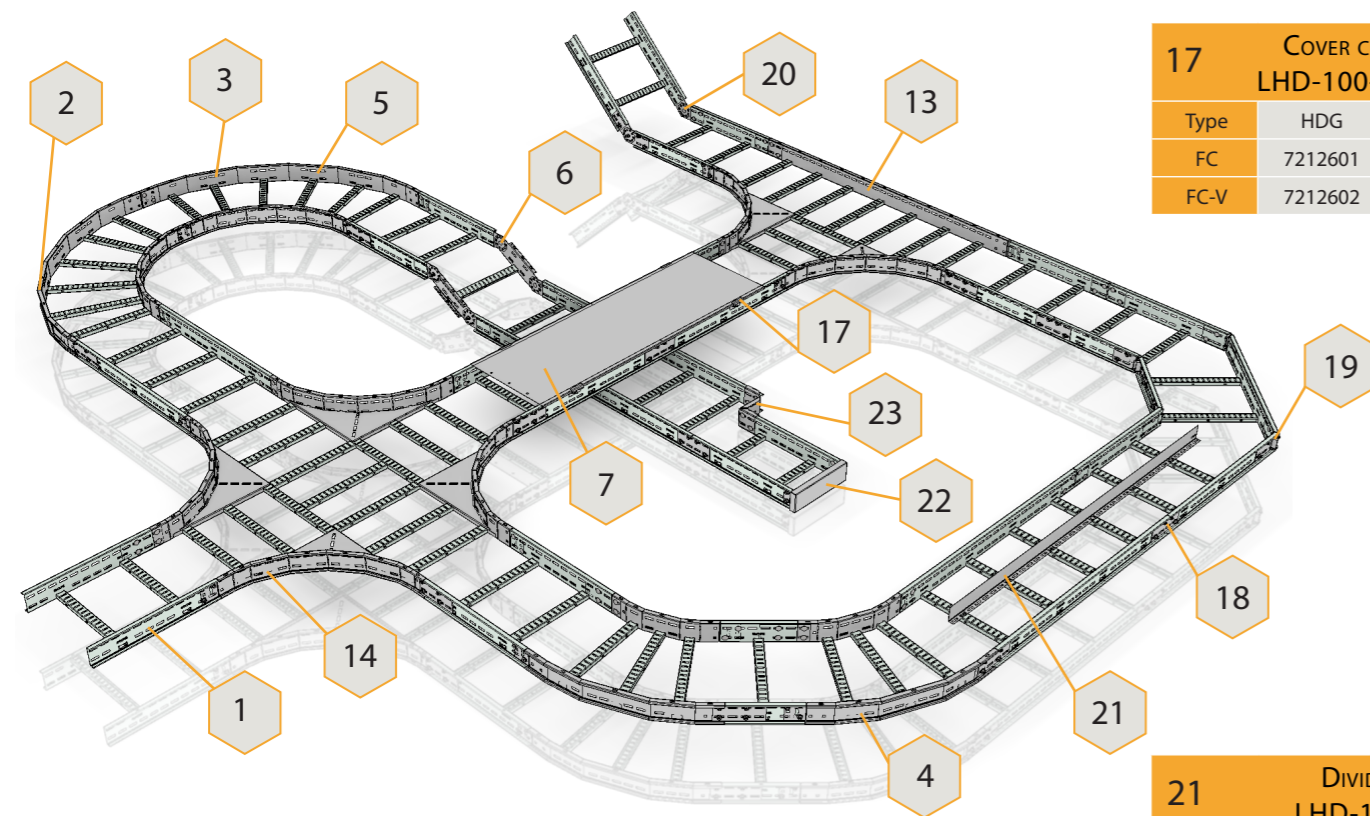

17 COVER CLAMP LHD-100-CO-FC		
Type	HDG	SS4
FC	7212601	7232601
FC-V	7212602	7232602

13 T-PIECE LHD-100-TE		
Width	HDG	SS4
150	7211355	7231355
300	7211356	7231356
450	7211357	7231357
500	7211358	7231358
600	7211359	7231359
700	7211360	7231360
750	7211361	7231361
800	7211362	7231362
900	7211363	7231363

14 X-PIECE LHD-100-XE		
Width	HDG	SS4
150	7211455	7231455
300	7211456	7231456
450	7211457	7231457
500	7211458	7231458
600	7211459	7231459
700	7211460	7231460
750	7211461	7231461
800	7211462	7231462
900	7211463	7231463

18 SPLICE CONNECTOR LHD-100-SC		
HDG	SS4	
7211501	7231501	

19 HINGE HORIZONTAL LHD-100-HI-G		
HDG	SS4	
7211601	7231601	

20 HINGE VERTICAL LHD-100-HI-V		
HDG	SS4	
7211701	7231701	

21 DIVIDER LHD-100-DI		
Type	HDG	SS4
DI	7113701	7133701
DI-FE	7113801	7133801
DI-FR	7116201	7136201

15 COVER T LHD-CO-TE		
Width	HDG	SS4
150	7212319	7232319
300	7212320	7232320
450	7212321	7232321
500	7212322	7232322
600	7212323	7232323
700	7212324	7232324
750	7212325	7232325
800	7212326	7232326
900	7212327	7232327

16 COVER X LHD-CO-XE		
Width	HDG	SS4
150	7212419	7232419
300	7212420	7232420
450	7212421	7232421
500	7212422	7232422
600	7212423	7232423
700	7212424	7232424
750	7212425	7232425
800	7212426	7232426
900	7212427	7232427

22 END CAP LHD-100-EC		
Width	HDG	SS4
150	7214901	7234901
300	7214902	7234902
450	7214903	7234903
500	7214904	7234904
600	7214905	7234905
700	7214906	7234906
750	7214907	7234907
800	7214908	7234908
900	7214909	7234909

23 REDUCER LHD-100-RP		
Width	HDG	SS4
100	7213901	7233901
150	7213902	7233902
300	7213903	7233903
450	7213904	7233904
500	7213905	7233905
600	7213906	7233906
750	7213907	7233907

Designation structure							
series	height, mm	type	width, mm	thickness, mm	length, m	radius	material
LHD	100	CL	150	1,5	3	-	HDG
LHD	100	FE-90	300	1,5	-	R900	SS4
Title							
Cable ladder LHD - 100 - CL - 150 - 1,5 - 3 - HDG							
FLAT ELBOW 90° LHD - 100 - FE - 90 - 300 - 1,5 - R900 - SS4							

Accepted symbols:
 high loads from cables and external influences
 HDG - hot-dip galvanized steel
 SS4 - stainless steel, resistance class D*
 * - corrosion resistance classification according to GOST R 52868-20211
 Note:
 Cable tray thickness 2 mm available on request



Cable ladder system LHD-125 R=300 HDG/SS4

1 CABLE LADDER LHD-125-CL		
Width	HDG	SS4
150	7210610	7230610
300	7210611	7230611
450	7210612	7230612
500	7210613	7230613
600	7210614	7230614
700	7210615	7230615
750	7210616	7230616
800	7210617	7230617
900	7210618	7230618

2 FLAT ELBOW 90° LHD-125-FE-90		
Width	HDG	SS4
150	7210810	7230810
300	7210811	7230811
450	7210812	7230812
500	7210813	7230813
600	7210814	7230814
700	7210815	7230815
750	7210816	7230816
800	7210817	7230817
900	7210818	7230818

3 FLAT ELBOW 60° LHD-125-FE-60		
Width	HDG	SS4
150	7210910	7230910
300	7210911	7230911
450	7210912	7230912
500	7210913	7230913
600	7210914	7230914
700	7210915	7230915
750	7210916	7230916
800	7210917	7230917
900	7210918	7230918

4 FLAT ELBOW 45° LHD-125-FE-45		
Width	HDG	SS4
150	7211010	7231010
300	7211011	7231011
450	7211012	7231012
500	7211013	7231013
600	7211014	7231014
700	7211015	7231015
750	7211016	7231016
800	7211017	7231017
900	7211018	7231018

5 FLAT ELBOW 30° LHD-125-FE-30		
Width	HDG	SS4
150	7211110	7231110
300	7211111	7231111
450	7211112	7231112
500	7211113	7231113
600	7211114	7231114
700	7211115	7231115
750	7211116	7231116
800	7211117	7231117
900	7211118	7231118

6 FLEXI RISER LHD-125-FR		
Width	HDG	SS4
150	7211210	7231210
300	7211211	7231211
450	7211212	7231212
500	7211213	7231213
600	7211214	7231214
700	7211215	7231215
750	7211216	7231216
800	7211217	7231217
900	7211218	7231218

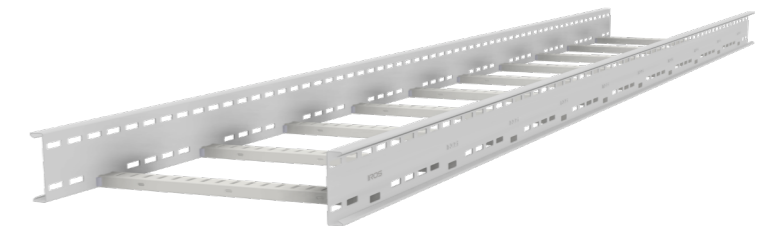

7 COVER LHD-CO		
Width	HDG	SS4
150	7212104	7232104
300	7212105	7232105
450	7212106	7232106
500	7212107	7232107
600	7212108	7232108
700	7212109	7232109
750	7212110	7232110
800	7212111	7232111
900	7212112	7232112

8 COVER 90° LHD-CO-90		
Width	HDG	SS4
150	7212201	7232201
300	7212202	7232202
450	7212203	7232203
500	7212204	7232204
600	7212205	7232205
700	7212206	7232206
750	7212207	7232207
800	7212208	7232208
900	7212209	7232209

9 COVER 60° LHD-CO-60		
Width	HDG	SS4
150	7214201	7234201
300	7214202	7234202
450	7214203	7234203
500	7214204	7234204
600	7214205	7234205
700	7214206	7234206
750	7214207	7234207
800	7214208	7234208
900	7214209	7234209

10 COVER 45° LHD-CO-45		
Width	HDG	SS4
150	7213601	7233601
300	7213602	7233602
450	7213603	7233603
500	7213604	7233604
600	7213605	7233605
700	7213606	7233606
750	7213607	7233607
800	7213608	7233608
900	7213609	7233609

11 COVER 30° LHD-CO-30		
Width	HDG	SS4
150	7216101	7236101
300	7216102	7236102
450	7216103	7236103
500	7216104	7236104
600	7216105	7236105
700	7216106	7236106
750	7216107	7236107
800	7216108	7236108
900	7216109	7236109

12 COVER RISER LHD-CO-FR		
Width	HDG	SS4
150	7212501	7232501
300	7212502	7232502
450	7212503	7232503
500	7212504	7232504
600	7212505	7232505
700	7212506	7232506
750	7212507	7232507
800	7212508	7232508
900	7212509	7232509

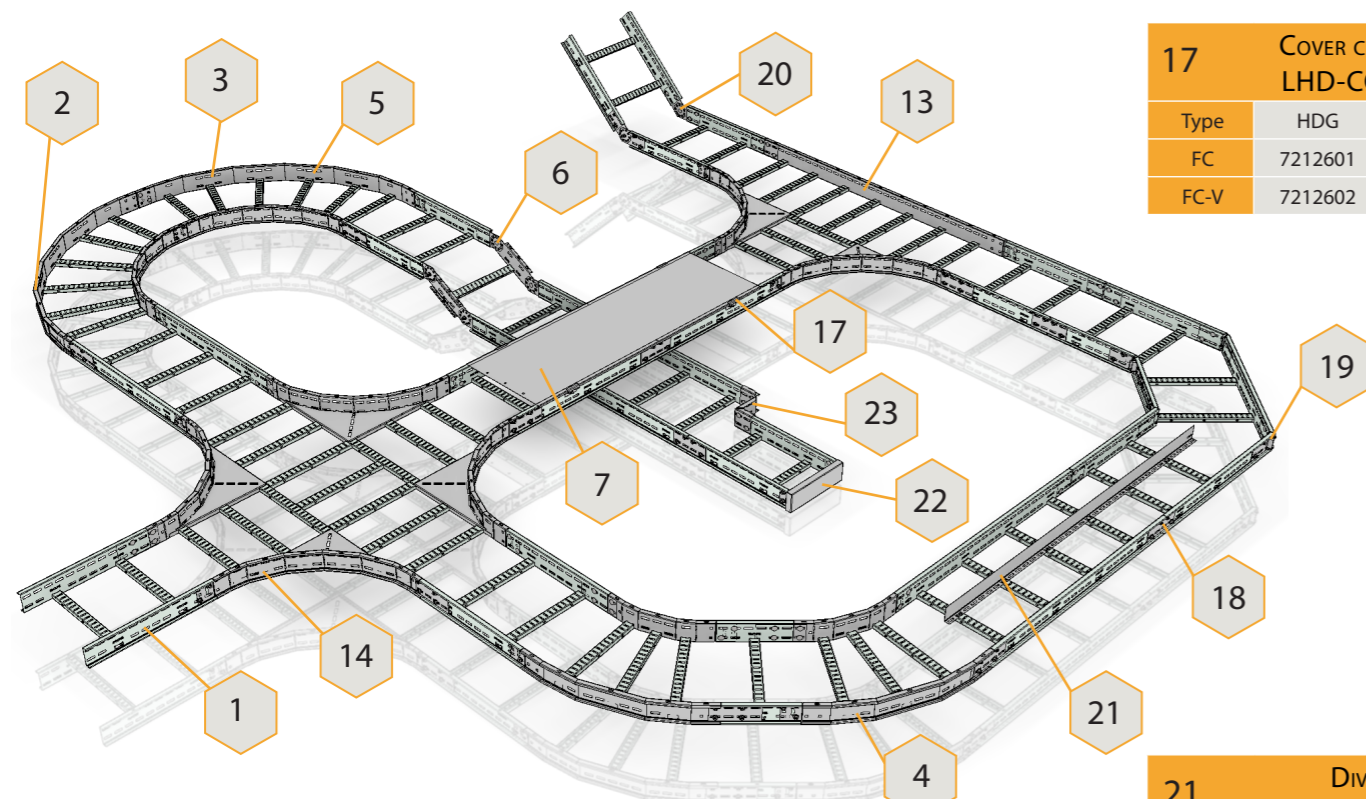

17 COVER CLAMP LHD-CO-FC		
Type	HDG	SS4
FC	7212601	7232601
FC-V	7212602	7232602

13 T-PIECE LHD-125-TE		
Width	HDG	SS4
150	7211310	7231310
300	7211311	7231311
450	7211312	7231312
500	7211313	7231313
600	7211314	7231314
700	7211315	7231315
750	7211316	7231316
800	7211317	7231317
900	7211318	7231318

14 X-PIECE LHD-125-XE		
Width	HDG	SS4
150	7211410	7231410
300	7211411	7231411
450	7211412	7231412
500	7211413	7231413
600	7211414	7231414
700	7211415	7231415
750	7211416	7231416
800	7211417	7231417
900	7211418	7231418

Designation structure							
series	height, mm	type	width, mm	thickness, mm	length, m	radius	material
LHD	125	CL	150	1,5	3	-	HDG
LHD	125	FE-90	300	1,5	-	R300	SS4
Title							
Cable ladder LHD - 125 - CL - 150 - 1,5 - 3 - HDG							
FLAT ELBOW 90° LHD - 125 - FE - 90 - 300 - 1,5 - R300 - SS4							

Accepted symbols:
 high loads from cables and external influences
 HDG - hot-dip galvanized steel
 SS4 - stainless steel, resistance class D*
 * - corrosion resistance classification according to GOST R 52868-20211
 Note:
 Cable tray thickness 2 mm available on request



18 SPLICE CONNECTOR LHD-125-SC	
HDG	SS4
7211502	7231502

19 HINGE HORIZONTAL LHD-125-HI-G	
HDG	SS4
7211602	7231602

20 HINGE VERTICAL LHD-125-HI-V	
HDG	SS4
7211702	7231702

21 DIVIDER LHD-125-DI		
Type	HDG	SS4
DI	7113702	7133702
DI-FE	7113802	7133802
DI-FR	7116202	7136202

15 COVER T LHD-CO-TE		
Width	HDG	SS4
150	7212301	7232301
300	7212302	7232302
450	7212303	7232303
500	7212304	7232304
600	7212305	7232305
700	7212306	7232306
750	7212307	7232307
800	7212308	7232308
900	7212309	7232309

16 COVER X LHD-CO-XE		
Width	HDG	SS4
150	7212401	7232401
300	7212402	7232402
450	7212403	7232403
500	7212404	7232404
600	7212405	7232405
700	7212406	7232406
750	7212407	7232407
800	7212408	7232408
900	7212409	7232409

22 END CAP LHD-125-EC		
Width	HDG	SS4
150	7214910	7234910
300	7214911	7234911
450	7214912	7234912
500	7214913	7234913
600	7214914	7234914
700	7214915	7234915
750	7214916	7234916
800	7214917	7234917
900	7214918	7234918

23 REDUCER LHD-125-RP		
Width	HDG	SS4
100	7213908	7233908
150	7213909	7233909
300	7213910	7233910
450	7213911	7233911
500	7213912	7233912
600	7213913	7233913
750	7213914	7233914

Cable ladder system LHD-125 R=600 HDG/SS4

1 CABLE LADDER LHD-125-CL		
Width	HDG	SS4
150	7210610	7230610
300	7210611	7230611
450	7210612	7230612
500	7210613	7230613
600	7210614	7230614
700	7210615	7230615
750	7210616	7230616
800	7210617	7230617
900	7210618	7230618

2 FLAT ELBOW 90° LHD-125-FE-90		
Width	HDG	SS4
150	7210837	7230837
300	7210838	7230838
450	7210839	7230839
500	7210840	7230840
600	7210841	7230841
700	7210842	7230842
750	7210843	7230843
800	7210844	7230844
900	7210845	7230845

3 FLAT ELBOW 60° LHD-125-FE-60		
Width	HDG	SS4
150	7210937	7230937
300	7210938	7230938
450	7210939	7230939
500	7210940	7230940
600	7210941	7230941
700	7210942	7230942
750	7210943	7230943
800	7210944	7230944
900	7210945	7230945

4 FLAT ELBOW 45° LHD-125-FE-45		
Width	HDG	SS4
150	7211037	7231037
300	7211038	7231038
450	7211039	7231039
500	7211040	7231040
600	7211041	7231041
700	7211042	7231042
750	7211043	7231043
800	7211044	7231044
900	7211045	7231045

5 FLAT ELBOW 30° LHD-125-FE-30		
Width	HDG	SS4
150	7211137	7231137
300	7211138	7231138
450	7211139	7231139
500	7211140	7231140
600	7211141	7231141
700	7211142	7231142
750	7211143	7231143
800	7211144	7231144
900	7211145	7231145

6 FLEXI RISER LHD-125-FR		
Width	HDG	SS4
150	7211237	7231237
300	7211238	7231238
450	7211239	7231239
500	7211240	7231240
600	7211241	7231241
700	7211242	7231242
750	7211243	7231243
800	7211244	7231244
900	7211245	7231245

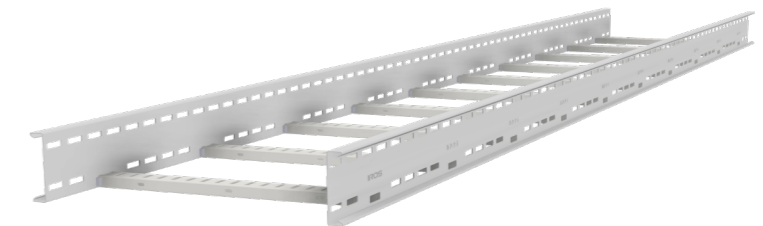

7 COVER LHD-CO		
Width	HDG	SS4
150	7212104	7232104
300	7212105	7232105
450	7212106	7232106
500	7212107	7232107
600	7212108	7232108
700	7212109	7232109
750	7212110	7232110
800	7212111	7232111
900	7212112	7232112

8 COVER 90° LHD-CO-90		
Width	HDG	SS4
150	7212210	7232210
300	7212211	7232211
450	7212212	7232212
500	7212213	7232213
600	7212214	7232214
700	7212215	7232215
750	7212216	7232216
800	7212217	7232217
900	7212218	7232218

9 COVER 60° LHD-CO-60		
Width	HDG	SS4
150	7214210	7234210
300	7214211	7234211
450	7214212	7234212
500	7214213	7234213
600	7214214	7234214
700	7214215	7234215
750	7214216	7234216
800	7214217	7234217
900	7214218	7234218

10 COVER 45° LHD-CO-45		
Width	HDG	SS4
150	7213610	7233610
300	7213611	7233611
450	7213612	7233612
500	7213613	7233613
600	7213614	7233614
700	7213615	7233615
750	7213616	7233616
800	7213617	7233617
900	7213618	7233618

11 COVER 30° LHD-CO-30		
Width	HDG	SS4
150	7216110	7236110
300	7216111	7236111
450	7216112	7236112
500	7216113	7236113
600	7216114	7236114
700	7216115	7236115
750	7216116	7236116
800	7216117	7236117
900	7216118	7236118

12 COVER RISER LHD-CO-FR		
Width	HDG	SS4
150	7212510	7232510
300	7212511	7232511
450	7212512	7232512
500	7212513	7232513
600	7212514	7232514
700	7212515	7232515
750	7212516	7232516
800	7212517	7232517
900	7212518	7232518

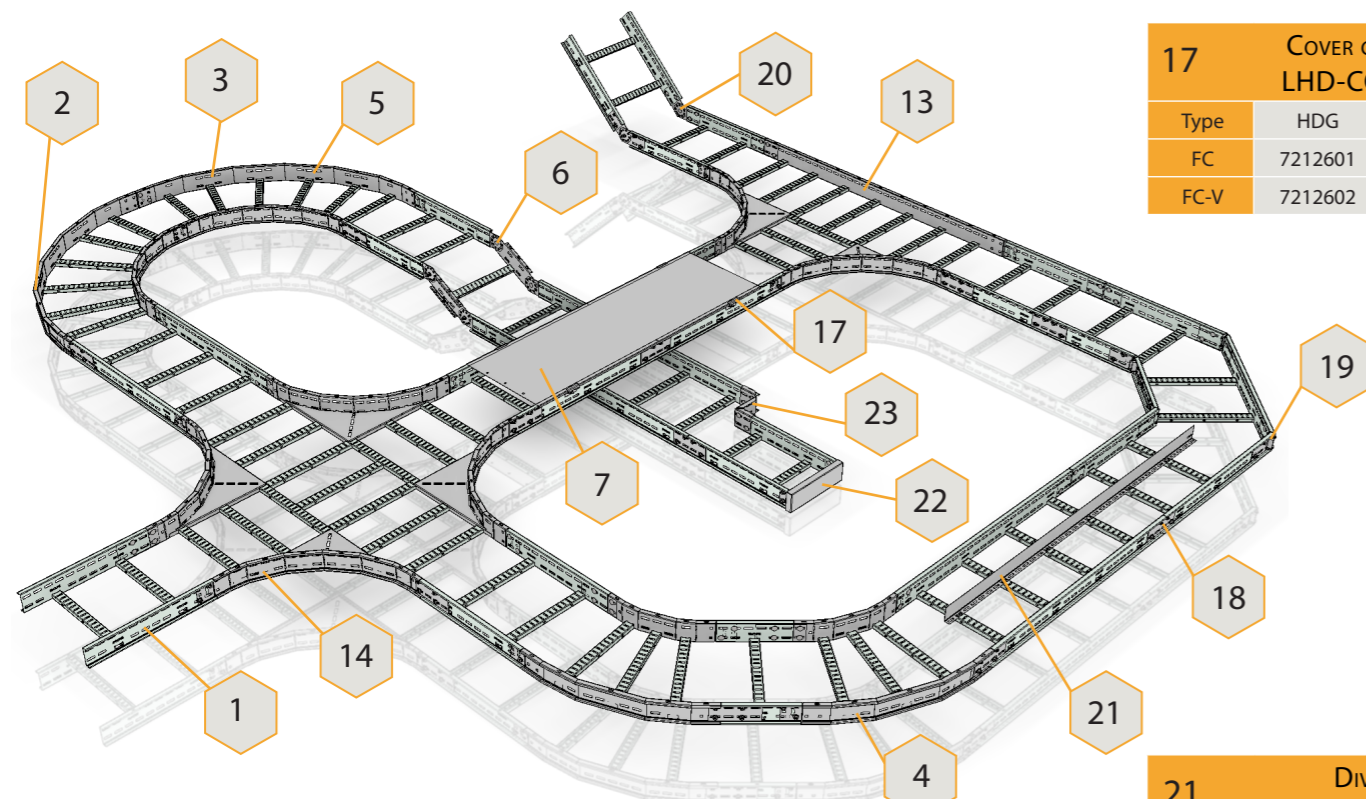

17 COVER CLAMP LHD-CO-FC		
Type	HDG	SS4
FC	7212601	7232601
FC-V	7212602	7232602

13 T-PIECE LHD-125-TE		
Width	HDG	SS4
150	7211337	7231337
300	7211338	7231338
450	7211339	7231339
500	7211340	7231340
600	7211341	7231341
700	7211342	7231342
750	7211343	7231343
800	7211344	7231344
900	7211345	7231345

14 X-PIECE LHD-125-XE		
Width	HDG	SS4
150	7211437	7231437
300	7211438	7231438
450	7211439	7231439
500	7211440	7231440
600	7211441	7231441
700	7211442	7231442
750	7211443	7231443
800	7211444	7231444
900	7211445	7231445

18 SPLICE CONNECTOR LHD-125-SC		
HDG	SS4	
7211502	7231502	

19 HINGE HORIZONTAL LHD-125-HI-G		
HDG	SS4	
7211602	7231602	

20 HINGE VERTICAL LHD-125-HI-V		
HDG	SS4	
7211702	7231702	

21 DIVIDER LHD-125-DI		
Type	HDG	SS4
DI	7113702	7133702
DI-FE	7113802	7133802
DI-FR	7116202	7136202

15 COVER T LHD-CO-TE		
Width	HDG	SS4
150	7212310	7232310
300	7212311	7232311
450	7212312	7232312
500	7212313	7232313
600	7212314	7232314
700	7212315	7232315
750	7212316	7232316
800	7212317	7232317
900	7212318	7232318

16 COVER X LHD-CO-XE		
Width	HDG	SS4
150	7212410	7232410
300	7212411	7232411
450	7212412	7232412
500	7212413	7232413
600	7212414	7232414
700	7212415	7232415
750	7212416	7232416
800	7212417	7232417
900	7212418	7232418

22 END CAP LHD-125-EC		
Width	HDG	SS4
150	7214910	7234910
300	7214911	7234911
450	7214912	7234912
500	7214913	7234913
600	7214914	7234914
700	7214915	7234915
750	7214916	7234916
800	7214917	7234917
900	7214918	7234918

23 REDUCER LHD-125-RP		
Width	HDG	SS4
100	7213908	7233908
150	7213909	7233909
300	7213910	7233910
450	7213911	7233911
500	7213912	7233912
600	7213913	7233913
750	7213914	7233914

Designation structure							
series	height, mm	type	width, mm	thickness, mm	length, m	radius	material
LHD	125	CL	150	1,5	3	-	HDG
LHD	125	FE-90	300	1,5	-	R600	SS4
Title							
Cable ladder		LHD - 125 - CL - 150 - 1,5 - 3 - HDG					
FLAT ELBOW 90°		LHD - 125 - FE - 90 - 300 - 1,5 - R600 - SS4					

Accepted symbols:
 high loads from cables and external influences
 HDG - hot-dip galvanized steel
 SS4 - stainless steel, resistance class D*
 * - corrosion resistance classification according to GOST R 52868-20211
 Note:
 Cable tray thickness 2 mm available on request



Cable ladder system LHD-125 R=900 HDG/SS4

1 CABLE LADDER LHD-125-CL		
Width	HDG	SS4
150	7210610	7230610
300	7210611	7230611
450	7210612	7230612
500	7210613	7230613
600	7210614	7230614
700	7210615	7230615
750	7210616	7230616
800	7210617	7230617
900	7210618	7230618

2 FLAT ELBOW 90° LHD-125-FE-90		
Width	HDG	SS4
150	7210864	7230864
300	7210865	7230865
450	7210866	7230866
500	7210867	7230867
600	7210868	7230868
700	7210869	7230869
750	7210870	7230870
800	7210871	7230871
900	7210872	7230872

3 FLAT ELBOW 60° LHD-125-FE-60		
Width	HDG	SS4
150	7210964	7230964
300	7210965	7230965
450	7210966	7230966
500	7210967	7230967
600	7210968	7230968
700	7210969	7230969
750	7210970	7230970
800	7210971	7230971
900	7210972	7230972

4 FLAT ELBOW 45° LHD-125-FE-45		
Width	HDG	SS4
150	7211064	7231064
300	7211065	7231065
450	7211066	7231066
500	7211067	7231067
600	7211068	7231068
700	7211069	7231069
750	7211070	7231070
800	7211071	7231071
900	7211072	7231072

5 FLAT ELBOW 30° LHD-125-FE-30		
Width	HDG	SS4
150	7211164	7231164
300	7211165	7231165
450	7211166	7231166
500	7211167	7231167
600	7211168	7231168
700	7211169	7231169
750	7211170	7231170
800	7211171	7231171
900	7211172	7231172

6 FLEXI RISER LHD-125-FR		
Width	HDG	SS4
150	7231264	7231237
300	7231265	7231238
450	7231266	7231239
500	7231267	7231240
600	7231268	7231241
700	7231269	7231242
750	7231270	7231243
800	7231271	7231244
900	7231272	7231245

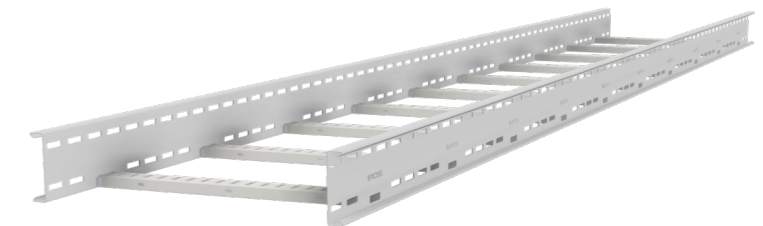

7 COVER LHD-CO		
Width	HDG	SS4
150	7212104	7232104
300	7212105	7232105
450	7212106	7232106
500	7212107	7232107
600	7212108	7232108
700	7212109	7232109
750	7212110	7232110
800	7212111	7232111
900	7212112	7232112

8 COVER 90° LHD-CO-90		
Width	HDG	SS4
150	7212219	7232219
300	7212220	7232220
450	7212221	7232221
500	7212222	7232222
600	7212223	7232223
700	7212224	7232224
750	7212225	7232225
800	7212226	7232226
900	7212227	7232227

9 COVER 60° LHD-CO-60		
Width	HDG	SS4
150	7214219	7234219
300	7214220	7234220
450	7214221	7234221
500	7214222	7234222
600	7214223	7234223
700	7214224	7234224
750	7214225	7234225
800	7214226	7234226
900	7214227	7234227

10 COVER 45° LHD-CO-45		
Width	HDG	SS4
150	7213619	7233619
300	7213620	7233620
450	7213621	7233621
500	7213622	7233622
600	7213623	7233623
700	7213624	7233624
750	7213625	7233625
800	7213626	7233626
900	7213627	7233627

11 COVER 30° LHD-CO-30		
Width	HDG	SS4
150	7216119	7236119
300	7216120	7236120
450	7216121	7236121
500	7216122	7236122
600	7216123	7236123
700	7216124	7236124
750	7216125	7236125
800	7216126	7236126
900	7216127	7236127

12 COVER RISER LHD-CO-FR		
Width	HDG	SS4
150	7212519	7232519
300	7212520	7232520
450	7212521	7232521
500	7212522	7232522
600	7212523	7232523
700	7212524	7232524
750	7212525	7232525
800	7212526	7232526
900	7212527	7232527

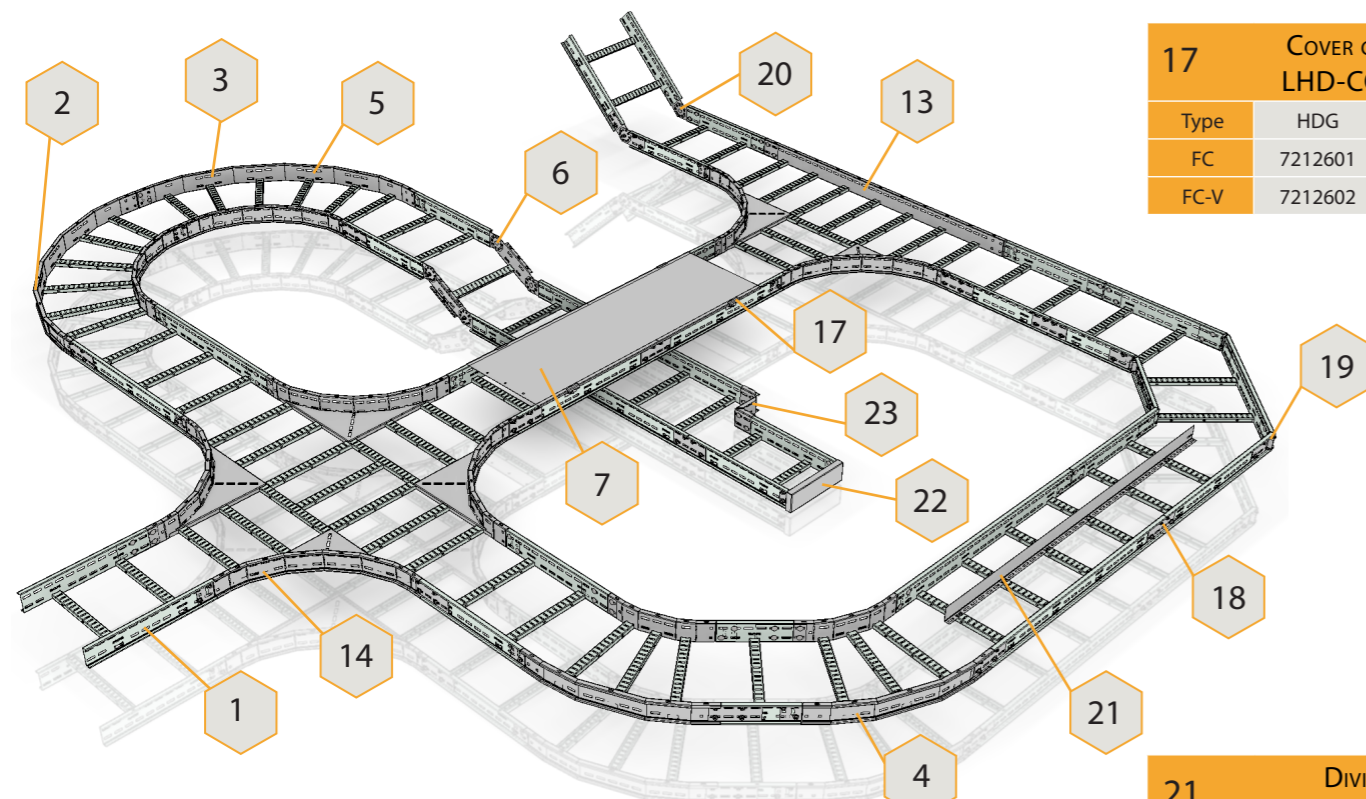

17 COVER CLAMP LHD-CO-FC		
Type	HDG	SS4
FC	7212601	7232601
FC-V	7212602	7232602

13 T-PIECE LHD-125-TE		
Width	HDG	SS4
150	7211364	7231364
300	7211365	7231365
450	7211366	7231366
500	7211367	7231367
600	7211368	7231368
700	7211369	7231369
750	7211370	7231370
800	7211371	7231371
900	7211372	7231372

14 X-PIECE LHD-125-XE		
Width	HDG	SS4
150	7211464	7231464
300	7211465	7231465
450	7211466	7231466
500	7211467	7231467
600	7211468	7231468
700	7211469	7231469
750	7211470	7231470
800	7211471	7231471
900	7211472	7231472

Designation structure							
series	height, mm	type	width, mm	thickness, mm	length, m	radius	material
LHD	125	CL	150	1,5	3	-	HDG
LHD	125	FE-90	300	1,5	-	R900	SS4
Title							
Cable ladder LHD - 125 - CL - 150 - 1,5 - 3 - HDG							
FLAT ELBOW 90° LHD - 125 - FE - 90 - 300 - 1,5 - R900 - SS4							

Accepted symbols:
 high loads from cables and external influences
 HDG - hot-dip galvanized steel
 SS4 - stainless steel, resistance class D*
 * - corrosion resistance classification according to GOST R 52868-20211
 Note:
 Cable tray thickness 2 mm available on request



18 SPLICE CONNECTOR LHD-125-SC	
HDG	SS4
7211502	7231502

19 HINGE HORIZONTAL LHD-125-HI-G	
HDG	SS4
7211602	7231602

20 HINGE VERTICAL LHD-125-HI-V	
HDG	SS4
7211702	7231702

21 DIVIDER LHD-125-DI		
Type	HDG	SS4
DI	7113702	7133702
DI-FE	7113802	7133802
DI-FR	7116202	7136202

15 COVER T LHD-CO-TE		
Width	HDG	SS4
150	7212319	7232319
300	7212320	7232320
450	7212321	7232321
500	7212322	7232322
600	7212323	7232323
700	7212324	7232324
750	7212325	7232325
800	7212326	7232326
900	7212327	7232327

16 COVER X LHD-CO-XE		
Width	HDG	SS4
150	7212419	7232419
300	7212420	7232420
450	7212421	7232421
500	7212422	7232422
600	7212423	7232423
700	7212424	7232424
750	7212425	7232425
800	7212426	7232426
900	7212427	7232427

22 END CAP LHD-125-EC		
Width	HDG	SS4
150	7214910	7234910
300	7214911	7234911
450	7214912	7234912
500	7214913	7234913
600	7214914	7234914
700	7214915	7234915
750	7214916	7234916
800	7214917	7234917
900	7214918	7234918

23 REDUCER LHD-125-RP		
Width	HDG	SS4
100	7213908	7233908
150	7213909	7233909
300	7213910	7233910
450	7213911	7233911
500	7213912	7233912
600	7213913	7233913
750	7213914	7233914

Cable ladder system LHD-150 R=300 HDG/SS4

1 CABLE LADDER LHD-150-CL		
Width	HDG	SS4
150	7210619	7230619
300	7210620	7230620
450	7210621	7230621
500	7210622	7230622
600	7210623	7230623
700	7210624	7230624
750	7210625	7230625
800	7210626	7230626
900	7210627	7230627

2 FLAT ELBOW 90° LHD-150-FE-90		
Width	HDG	SS4
150	7210819	7230819
300	7210820	7230820
450	7210821	7230821
500	7210822	7230822
600	7210823	7230823
700	7210824	7230824
750	7210825	7230825
800	7210826	7230826
900	7210827	7230827

3 FLAT ELBOW 60° LHD-150-FE-60		
Width	HDG	SS4
150	7210919	7230919
300	7210920	7230920
450	7210921	7230921
500	7210922	7230922
600	7210923	7230923
700	7210924	7230924
750	7210925	7230925
800	7210926	7230926
900	7210927	7230927

4 FLAT ELBOW 45° LHD-150-FE-45		
Width	HDG	SS4
150	7211019	7231019
300	7211020	7231020
450	7211021	7231021
500	7211022	7231022
600	7211023	7231023
700	7211024	7231024
750	7211025	7231025
800	7211026	7231026
900	7211027	7231027

5 FLAT ELBOW 30° LHD-150-FE-30		
Width	HDG	SS4
150	7211119	7231119
300	7211120	7231120
450	7211121	7231121
500	7211122	7231122
600	7211123	7231123
700	7211124	7231124
750	7211125	7231125
800	7211126	7231126
900	7211127	7231127

6 FLEXI RISER LHD-150-FR		
Width	HDG	SS4
150	7211219	7231219
300	7211220	7231220
450	7211221	7231221
500	7211222	7231222
600	7211223	7231223
700	7211224	7231224
750	7211225	7231225
800	7211226	7231226
900	7211227	7231227

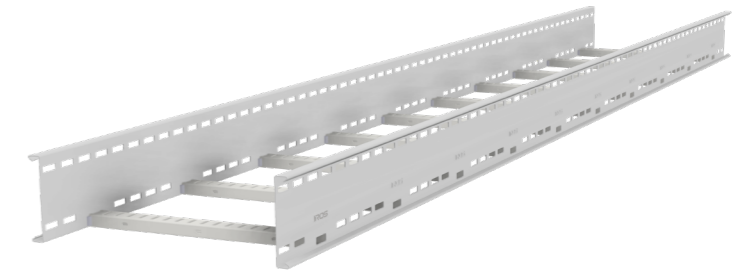

7 COVER LHD-CO		
Width	HDG	SS4
150	7212104	7232104
300	7212105	7232105
450	7212106	7232106
500	7212107	7232107
600	7212108	7232108
700	7212109	7232109
750	7212110	7232110
800	7212111	7232111
900	7212112	7232112

8 COVER 90° LHD-CO-90		
Width	HDG	SS4
150	7212201	7232201
300	7212202	7232202
450	7212203	7232203
500	7212204	7232204
600	7212205	7232205
700	7212206	7232206
750	7212207	7232207
800	7212208	7232208
900	7212209	7232209

9 COVER 60° LHD-CO-60		
Width	HDG	SS4
150	7214201	7234201
300	7214202	7234202
450	7214203	7234203
500	7214204	7234204
600	7214205	7234205
700	7214206	7234206
750	7214207	7234207
800	7214208	7234208
900	7214209	7234209

10 COVER 45° LHD-CO-45		
Width	HDG	SS4
150	7213601	7233601
300	7213602	7233602
450	7213603	7233603
500	7213604	7233604
600	7213605	7233605
700	7213606	7233606
750	7213607	7233607
800	7213608	7233608
900	7213609	7233609

11 COVER 30° LHD-CO-30		
Width	HDG	SS4
150	7216101	7236101
300	7216102	7236102
450	7216103	7236103
500	7216104	7236104
600	7216105	7236105
700	7216106	7236106
750	7216107	7236107
800	7216108	7236108
900	7216109	7236109

12 COVER RISER LHD-CO-FR		
Width	HDG	SS4
150	7212501	7232501
300	7212502	7232502
450	7212503	7232503
500	7212504	7232504
600	7212505	7232505
700	7212506	7232506
750	7212507	7232507
800	7212508	7232508
900	7212509	7232509

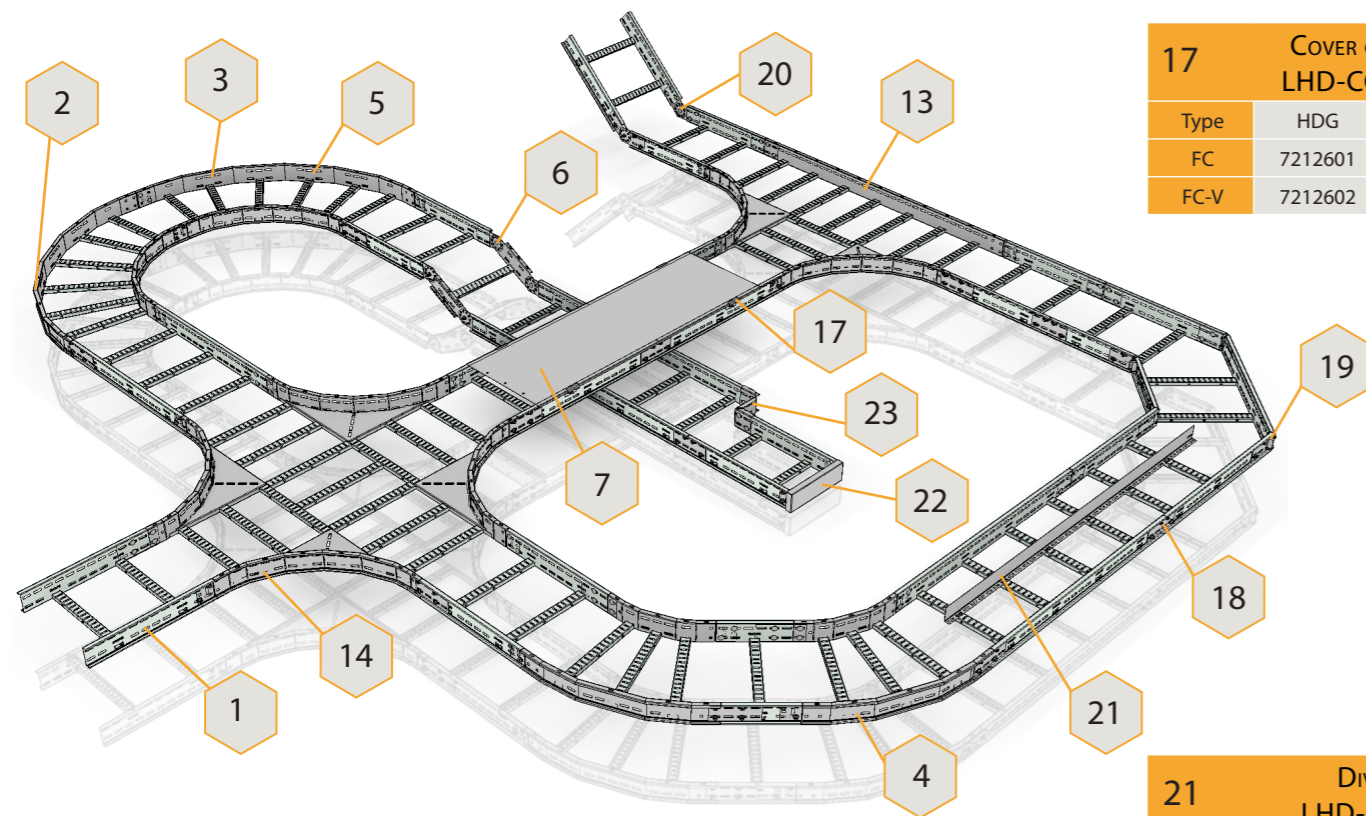

17 COVER CLAMP LHD-CO-FC		
Type	HDG	SS4
FC	7212601	7232601
FC-V	7212602	7232602

13 T-PIECE LHD-150-TE		
Width	HDG	SS4
150	7211319	7231319
300	7211320	7231320
450	7211321	7231321
500	7211322	7231322
600	7211323	7231323
700	7211324	7231324
750	7211325	7231325
800	7211326	7231326
900	7211327	7231327

14 X-PIECE LHD-150-XE		
Width	HDG	SS4
150	7211419	7231419
300	7211420	7231420
450	7211421	7231421
500	7211422	7231422
600	7211423	7231423
700	7211424	7231424
750	7211425	7231425
800	7211426	7231426
900	7211427	7231427

18 SPLICE CONNECTOR LHD-150-SC		
HDG	SS4	
7211503	7231503	

19 HINGE HORIZONTAL LHD-150-HI-G		
HDG	SS4	
7211603	7231603	

20 HINGE VERTICAL LHD-150-HI-V		
HDG	SS4	
7211703	7231703	

21 DIVIDER LHD-150-DI		
Type	HDG	SS4
DI	7113703	7133703
DI-FE	7113803	7133803
DI-FR	7116203	7136203

15 COVER T LHD-CO-TE		
Width	HDG	SS4
150	7212301	7232301
300	7212302	7232302
450	7212303	7232303
500	7212304	7232304
600	7212305	7232305
700	7212306	7232306
750	7212307	7232307
800	7212308	7232308
900	7212309	7232309

16 COVER X LHD-CO-XE		
Width	HDG	SS4
150	7212401	7232401
300	7212402	7232402
450	7212403	7232403
500	7212404	7232404
600	7212405	7232405
700	7212406	7232406
750	7212407	7232407
800	7212408	7232408
900	7212409	7232409

22 END CAP LHD-150-EC		
Width	HDG	SS4
150	7214919	7234919
300	7214920	7234920
450	7214921	7234921
500	7214922	7234922
600	7214923	7234923
700	7214924	7234924
750	7214925	7234925
800	7214926	7234926
900	7214927	7234927

23 REDUCER LHD-150-RP		
Width	HDG	SS4
100	7213915	7233915
150	7213916	7233916
300	7213917	7233917
450	7213918	7233918
500	7213919	7233919
600	7213920	7233920
750	7213921	7233921

Designation structure							
series	height, mm	type	width, mm	thickness, mm	length, m	radius	material
LHD	150	CL	150	1,5	3	-	HDG
LHD	150	FE-90	300	1,5	-	R300	SS4
Title							
Cable ladder		LHD - 150 - CL - 150 - 1,5 - 3 - HDG					
FLAT ELBOW 90°		LHD - 150 - FE - 90 - 300 - 1,5 - R300 - SS4					

Accepted symbols:
 high loads from cables and external influences
 HDG - hot-dip galvanized steel
 SS4 - stainless steel, resistance class D*
 * - corrosion resistance classification according to GOST R 52868-20211
 Note:
 Cable tray thickness 2 mm available on request



Cable ladder system LHD-150 R=600 HDG/SS4

1 CABLE LADDER LHD-150-CL		
Width	HDG	SS4
150	7210619	7230619
300	7210620	7230620
450	7210621	7230621
500	7210622	7230622
600	7210623	7230623
700	7210624	7230624
750	7210625	7230625
800	7210626	7230626
900	7210627	7230627

2 FLAT ELBOW 90° LHD-150-FE-90		
Width	HDG	SS4
150	7210846	7230846
300	7210847	7230847
450	7210848	7230848
500	7210849	7230849
600	7210850	7230850
700	7210851	7230851
750	7210852	7230852
800	7210853	7230853
900	7210854	7230854

3 FLAT ELBOW 60° LHD-150-FE-60		
Width	HDG	SS4
150	7210946	7230946
300	7210947	7230947
450	7210948	7230948
500	7210949	7230949
600	7210950	7230950
700	7210951	7230951
750	7210952	7230952
800	7210953	7230953
900	7210954	7230954

4 FLAT ELBOW 45° LHD-150-FE-45		
Width	HDG	SS4
150	7211046	7231046
300	7211047	7231047
450	7211048	7231048
500	7211049	7231049
600	7211050	7231050
700	7211051	7231051
750	7211052	7231052
800	7211053	7231053
900	7211054	7231054

5 FLAT ELBOW 30° LHD-150-FE-30		
Width	HDG	SS4
150	7211146	7231146
300	7211147	7231147
450	7211148	7231148
500	7211149	7231149
600	7211150	7231150
700	7211151	7231151
750	7211152	7231152
800	7211153	7231153
900	7211154	7231154

6 FLEXI RISER LHD-150-FR		
Width	HDG	SS4
150	7211246	7231246
300	7211247	7231247
450	7211248	7231248
500	7211249	7231249
600	7211250	7231250
700	7211251	7231251
750	7211252	7231252
800	7211253	7231253
900	7211254	7231254

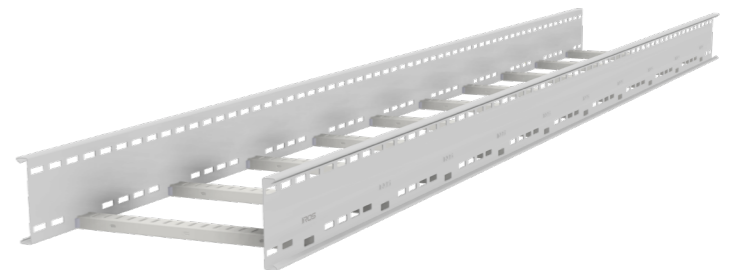

7 COVER LHD-CO		
Width	HDG	SS4
150	7212104	7232104
300	7212105	7232105
450	7212106	7232106
500	7212107	7232107
600	7212108	7232108
700	7212109	7232109
750	7212110	7232110
800	7212111	7232111
900	7212112	7232112

8 COVER 90° LHD-CO-90		
Width	HDG	SS4
150	7212210	7232210
300	7212211	7232211
450	7212212	7232212
500	7212213	7232213
600	7212214	7232214
700	7212215	7232215
750	7212216	7232216
800	7212217	7232217
900	7212218	7232218

9 COVER 60° LHD-CO-60		
Width	HDG	SS4
150	7214210	7234210
300	7214211	7234211
450	7214212	7234212
500	7214213	7234213
600	7214214	7234214
700	7214215	7234215
750	7214216	7234216
800	7214217	7234217
900	7214218	7234218

10 COVER 45° LHD-CO-45		
Width	HDG	SS4
150	7213610	7233610
300	7213611	7233611
450	7213612	7233612
500	7213613	7233613
600	7213614	7233614
700	7213615	7233615
750	7213616	7233616
800	7213617	7233617
900	7213618	7233618

11 COVER 30° LHD-CO-30		
Width	HDG	SS4
150	7216110	7236110
300	7216111	7236111
450	7216112	7236112
500	7216113	7236113
600	7216114	7236114
700	7216115	7236115
750	7216116	7236116
800	7216117	7236117
900	7216118	7236118

12 COVER RISER LHD-CO-FR		
Width	HDG	SS4
150	7212510	7232510
300	7212511	7232511
450	7212512	7232512
500	7212513	7232513
600	7212514	7232514
700	7212515	7232515
750	7212516	7232516
800	7212517	7232517
900	7212518	7232518

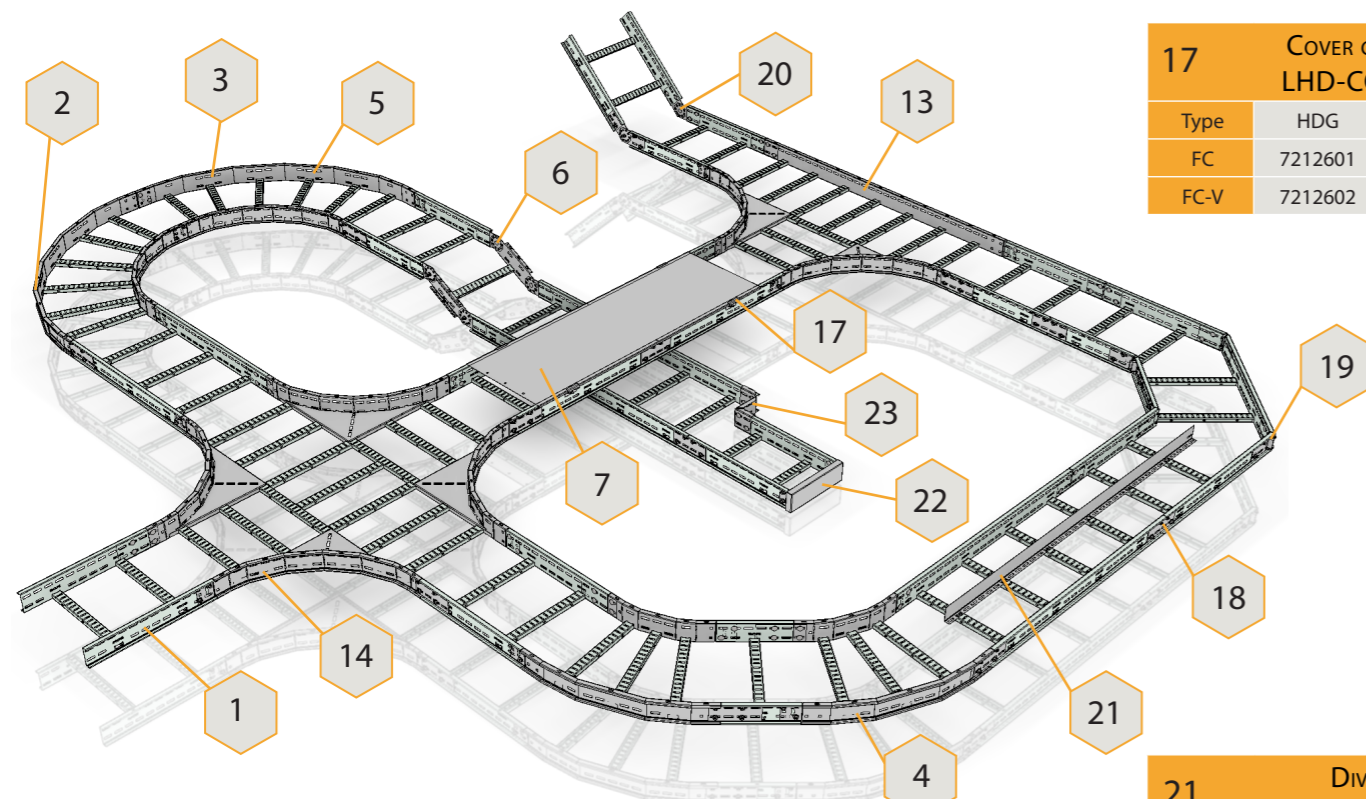

17 COVER CLAMP LHD-CO-FC		
Type	HDG	SS4
FC	7212601	7232601
FC-V	7212602	7232602

13 T-PIECE LHD-150-TE		
Width	HDG	SS4
150	7211346	7231346
300	7211347	7231347
450	7211348	7231348
500	7211349	7231349
600	7211350	7231350
700	7211351	7231351
750	7211352	7231352
800	7211353	7231353
900	7211354	7231354

14 X-PIECE LHD-150-XE		
Width	HDG	SS4
150	7211446	7231446
300	7211447	7231447
450	7211448	7231448
500	7211449	7231449
600	7211450	7231450
700	7211451	7231451
750	7211452	7231452
800	7211453	7231453
900	7211454	7231454

18 SPLICE CONNECTOR LHD-150-SC		
HDG	SS4	
7211503	7231503	

19 HINGE HORIZONTAL LHD-150-HI-G		
HDG	SS4	
7211603	7231603	

20 HINGE VERTICAL LHD-150-HI-V		
HDG	SS4	
7211703	7231703	

21 DIVIDER LHD-150-DI		
Type	HDG	SS4
DI	7113703	7133703
DI-FE	7113803	7133803
DI-FR	7116203	7136203

15 COVER T LHD-CO-TE		
Width	HDG	SS4
150	7212310	7232310
300	7212311	7232311
450	7212312	7232312
500	7212313	7232313
600	7212314	7232314
700	7212315	7232315
750	7212316	7232316
800	7212317	7232317
900	7212318	7232318

16 COVER X LHD-CO-XE		
Width	HDG	SS4
150	7212410	7232410
300	7212411	7232411
450	7212412	7232412
500	7212413	7232413
600	7212414	7232414
700	7212415	7232415
750	7212416	7232416
800	7212417	7232417
900	7212418	7232418

22 END CAP LHD-150-EC		
Width	HDG	SS4
150	7214919	7234919
300	7214920	7234920
450	7214921	7234921
500	7214922	7234922
600	7214923	7234923
700	7214924	7234924
750	7214925	7234925
800	7214926	7234926
900	7214927	7234927

23 REDUCER LHD-150-RP		
Width	HDG	SS4
100	7213915	7233915
150	7213916	7233916
300	7213917	7233917
450	7213918	7233918
500	7213919	7233919
600	7213920	7233920
750	7213921	7233921

Designation structure							
series	height, mm	type	width, mm	thickness, mm	length, m	radius	material
LHD	150	CL	150	1,5	3	-	HDG
LHD	150	FE-90	300	1,5	-	R600	SS4
Title							
Cable ladder		LHD - 150 - CL - 150 - 1,5 - 3 - HDG					
FLAT ELBOW 90°		LHD - 150 - FE - 90 - 300 - 1,5 - R600 - SS4					

Accepted symbols:
 high loads from cables and external influences
 HDG - hot-dip galvanized steel
 SS4 - stainless steel, resistance class D*
 * - corrosion resistance classification according to GOST R 52868-20211
 Note:
 Cable tray thickness 2 mm available on request



Cable ladder system LHD-150 R=900 HDG/SS4

1 CABLE LADDER LHD-150-CL		
Width	HDG	SS4
150	7210619	7230619
300	7210620	7230620
450	7210621	7230621
500	7210622	7230622
600	7210623	7230623
700	7210624	7230624
750	7210625	7230625
800	7210626	7230626
900	7210627	7230627

2 FLAT ELBOW 90° LHD-150-FE-90		
Width	HDG	SS4
150	7210873	7230873
300	7210874	7230874
450	7210875	7230875
500	7210876	7230876
600	7210877	7230877
700	7210878	7230878
750	7210879	7230879
800	7210880	7230880
900	7210881	7230881

3 FLAT ELBOW 60° LHD-150-FE-60		
Width	HDG	SS4
150	7210973	7230973
300	7210974	7230974
450	7210975	7230975
500	7210976	7230976
600	7210977	7230977
700	7210978	7230978
750	7210979	7230979
800	7210980	7230980
900	7210981	7230981

4 FLAT ELBOW 45° LHD-150-FE-45		
Width	HDG	SS4
150	7211073	7231073
300	7211074	7231074
450	7211075	7231075
500	7211076	7231076
600	7211077	7231077
700	7211078	7231078
750	7211079	7231079
800	7211080	7231080
900	7211081	7231081

5 FLAT ELBOW 30° LHD-150-FE-30		
Width	HDG	SS4
150	7211173	7231173
300	7211174	7231174
450	7211175	7231175
500	7211176	7231176
600	7211177	7231177
700	7211178	7231178
750	7211179	7231179
800	7211180	7231180
900	7211181	7231181

6 FLEXI RISER LHD-150-FR		
Width	HDG	SS4
150	7211273	7231273
300	7211274	7231274
450	7211275	7231275
500	7211276	7231276
600	7211277	7231277
700	7211278	7231278
750	7211279	7231279
800	7211280	7231280
900	7211281	7231281

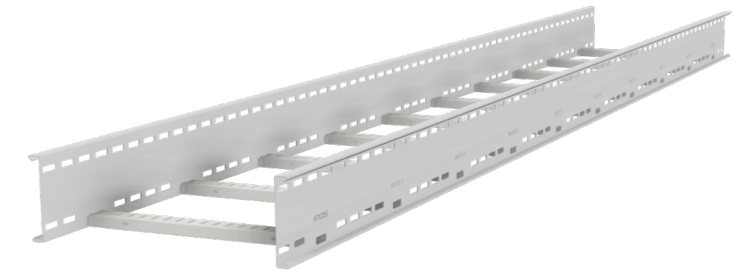

7 COVER LHD-CO		
Width	HDG	SS4
150	7212104	7232104
300	7212105	7232105
450	7212106	7232106
500	7212107	7232107
600	7212108	7232108
700	7212109	7232109
750	7212110	7232110
800	7212111	7232111
900	7212112	7232112

8 COVER 90° LHD-CO-90		
Width	HDG	SS4
150	7212219	7232219
300	7212220	7232220
450	7212221	7232221
500	7212222	7232222
600	7212223	7232223
700	7212224	7232224
750	7212225	7232225
800	7212226	7232226
900	7212227	7232227

9 COVER 60° LHD-CO-60		
Width	HDG	SS4
150	7214219	7234219
300	7214220	7234220
450	7214221	7234221
500	7214222	7234222
600	7214223	7234223
700	7214224	7234224
750	7214225	7234225
800	7214226	7234226
900	7214227	7234227

10 COVER 45° LHD-CO-45		
Width	HDG	SS4
150	7213619	7233619
300	7213620	7233620
450	7213621	7233621
500	7213622	7233622
600	7213623	7233623
700	7213624	7233624
750	7213625	7233625
800	7213626	7233626
900	7213627	7233627

11 COVER 30° LHD-CO-30		
Width	HDG	SS4
150	7216119	7236119
300	7216120	7236120
450	7216121	7236121
500	7216122	7236122
600	7216123	7236123
700	7216124	7236124
750	7216125	7236125
800	7216126	7236126
900	7216127	7236127

12 COVER RISER LHD-CO-FR		
Width	HDG	SS4
150	7212519	7232519
300	7212520	7232520
450	7212521	7232521
500	7212522	7232522
600	7212523	7232523
700	7212524	7232524
750	7212525	7232525
800	7212526	7232526
900	7212527	7232527

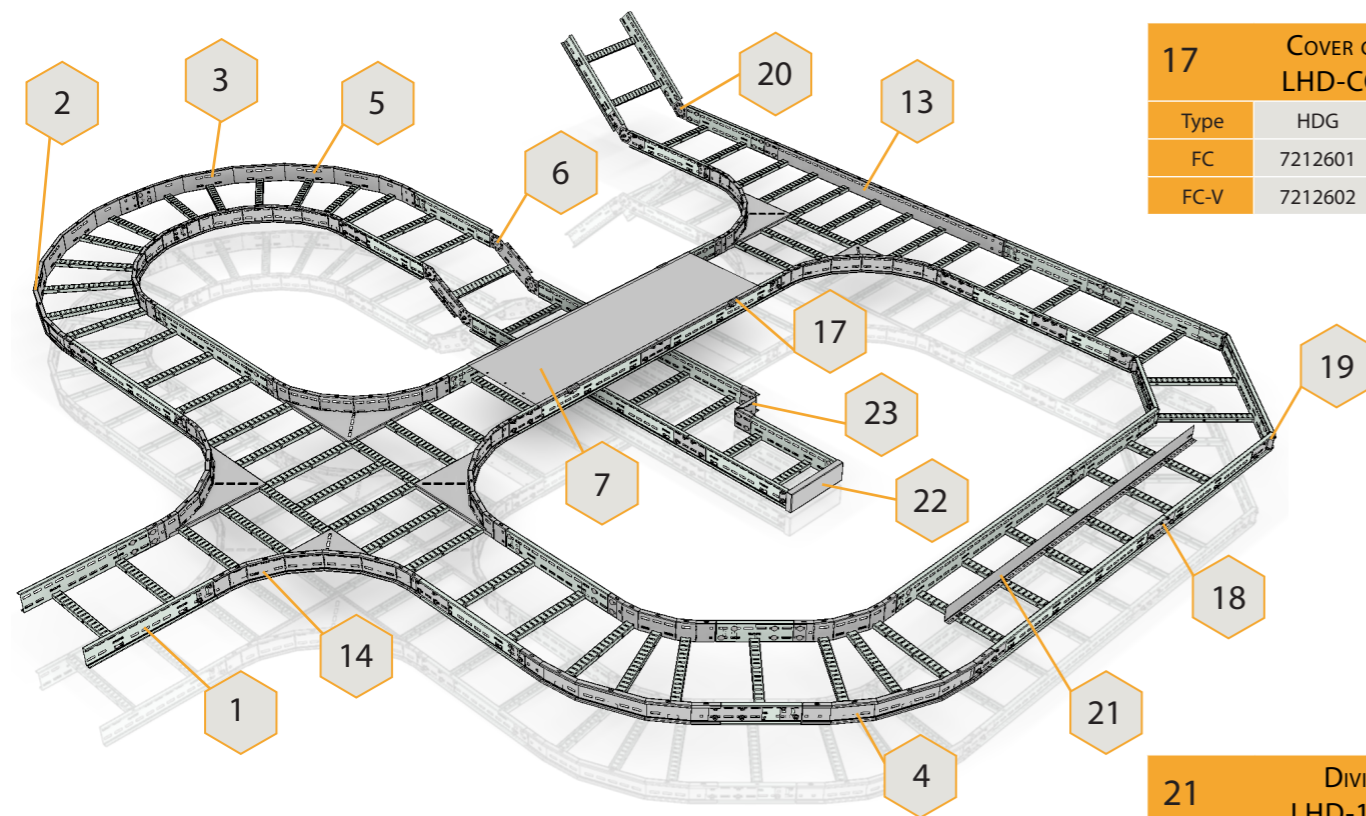

17 COVER CLAMP LHD-CO-FC		
Type	HDG	SS4
FC	7212601	7232601
FC-V	7212602	7232602

13 T-PIECE LHD-150-TE		
Width	HDG	SS4
150	7211373	7231373
300	7211374	7231374
450	7211375	7231375
500	7211376	7231376
600	7211377	7231377
700	7211378	7231378
750	7211379	7231379
800	7211380	7231380
900	7211381	7231381

14 X-PIECE LHD-150-XE		
Width	HDG	SS4
150	7211473	7231473
300	7211474	7231474
450	7211475	7231475
500	7211476	7231476
600	7211477	7231477
700	7211478	7231478
750	7211479	7231479
800	7211480	7231480
900	7211481	7231481

Designation structure							
series	height, mm	type	width, mm	thickness, mm	length, m	radius	material
LHD	150	CL	150	1,5	3	-	HDG
LHD	150	FE-90	300	1,5	-	R900	SS4
Title							
Cable ladder LHD - 150 - CL - 150 - 1,5 - 3 - HDG							
FLAT ELBOW 90° LHD - 150 - FE - 90 - 300 - 1,5 - R900 - SS4							

Accepted symbols:
 high loads from cables and external influences
 HDG - hot-dip galvanized steel
 SS4 - stainless steel, resistance class D*
 * - corrosion resistance classification according to GOST R 52868-20211
 Note:
 Cable tray thickness 2 mm available on request



18 SPLICE CONNECTOR LHD-150-SC		
HDG	SS4	
7211503	7231503	

19 HINGE HORIZONTAL LHD-150-HI-G		
HDG	SS4	
7211603	7231603	

20 HINGE VERTICAL LHD-150-HI-V		
HDG	SS4	
7211703	7231703	

21 DIVIDER LHD-150-DI		
Type	HDG	SS4
DI	7113703	7133703
DI-FE	7113803	7133803
DI-FR	7116203	7136203

15 COVER T LHD-CO-TE		
Width	HDG	SS4
150	7212319	7232319
300	7212320	7232320
450	7212321	7232321
500	7212322	7232322
600	7212323	7232323
700	7212324	7232324
750	7212325	7232325
800	7212326	7232326
900	7212327	7232327

16 COVER X LHD-CO-XE		
Width	HDG	SS4
150	7212419	7232419
300	7212420	7232420
450	7212421	7232421
500	7212422	7232422
600	7212423	7232423
700	7212424	7232424
750	7212425	7232425
800	7212426	7232426
900	7212427	7232427

22 END CAP LHD-150-EC		
Width	HDG	SS4
150	7214919	7234919
300	7214920	7234920
450	7214921	7234921
500	7214922	7234922
600	7214923	7234923
700	7214924	7234924
750	7214925	7234925
800	7214926	7234926
900	7214927	7234927

23 REDUCER LHD-150-RP		
Width	HDG	SS4
100	7213915	7233915
150	7213916	7233916
300	7213917	7233917
450	7213918	7233918
500	7213919	7233919
600	7213920	7233920
750	7213921	7233921

1	Ø,MM	Cable clamp CFC-T	SS4
1	25	CFC-T-25-SS4	78381105
2	27	CFC-T-27-SS4	78381106
3	29	CFC-T-29-SS4	78381107
4	31	CFC-T-31-SS4	78381108
5	33	CFC-T-33-SS4	78381109
6	35	CFC-T-35-SS4	78381110
7	37	CFC-T-37-SS4	7838101
8	39	CFC-T-39-SS4	7838102
9	41	CFC-T-41-SS4	7838103
10	43	CFC-T-43-SS4	7838104
11	45	CFC-T-45-SS4	7838105
12	47	CFC-T-47-SS4	7838106
13	49	CFC-T-49-SS4	7838107
14	51	CFC-T-51-SS4	7838108
15	53	CFC-T-53-SS4	7838109
16	55	CFC-T-55-SS4	7838110
17	57	CFC-T-57-SS4	7838111
18	59	CFC-T-59-SS4	7838112
19	60	CFC-T-60-SS4	7838163
20	61	CFC-T-61-SS4	7838164
21	62	CFC-T-62-SS4	7838165
22	63	CFC-T-63-SS4	7838166
23	64	CFC-T-64-SS4	7838167
24	65	CFC-T-65-SS4	7838168
25	66	CFC-T-66-SS4	7838169
26	67	CFC-T-67-SS4	7838170
27	68	CFC-T-68-SS4	7838171
28	69	CFC-T-69-SS4	7838172
29	70	CFC-T-70-SS4	7838173
30	71	CFC-T-71-SS4	7838174
31	72	CFC-T-72-SS4	7838175
32	73	CFC-T-73-SS4	7838176
33	74	CFC-T-74-SS4	7838177
34	75	CFC-T-75-SS4	7838178
35	76	CFC-T-76-SS4	7838179
36	77	CFC-T-77-SS4	7838180
37	78	CFC-T-78-SS4	7838181
38	79	CFC-T-79-SS4	7838182
39	80	CFC-T-80-SS4	7838183
40	81	CFC-T-81-SS4	7838184
41	82	CFC-T-82-SS4	7838185
42	83	CFC-T-83-SS4	7838186
43	84	CFC-T-84-SS4	7838187
44	85	CFC-T-85-SS4	7838188
45	86	CFC-T-86-SS4	7838189
46	87	CFC-T-87-SS4	7838190
47	88	CFC-T-88-SS4	7838191
48	89	CFC-T-89-SS4	7838192
49	90	CFC-T-90-SS4	7838193
50	91	CFC-T-91-SS4	7838194
51	92	CFC-T-92-SS4	7838195
52	93	CFC-T-93-SS4	7838196
53	94	CFC-T-94-SS4	7838197
54	95	CFC-T-95-SS4	7838198
55	96	CFC-T-96-SS4	7838199
56	97	CFC-T-97-SS4	78381100
57	98	CFC-T-98-SS4	78381101
58	99	CFC-T-99-SS4	78381102

Cable fixing clamp for high voltage CFC SS4

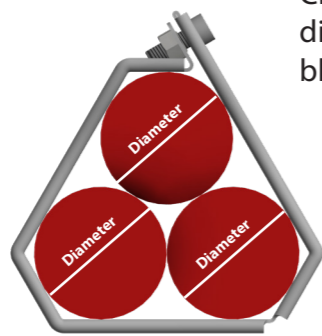

CFC-T clamps are designed for fixing cables with diameters from 25 to 99 mm. For triangular cable laying the diameter tolerance is +/- 1.5 mm



CFC-S clamps are designed for fixing cables with diameters from 37 to 99 mm. For single cables, the diameter tolerance is +/- 2.0 mm

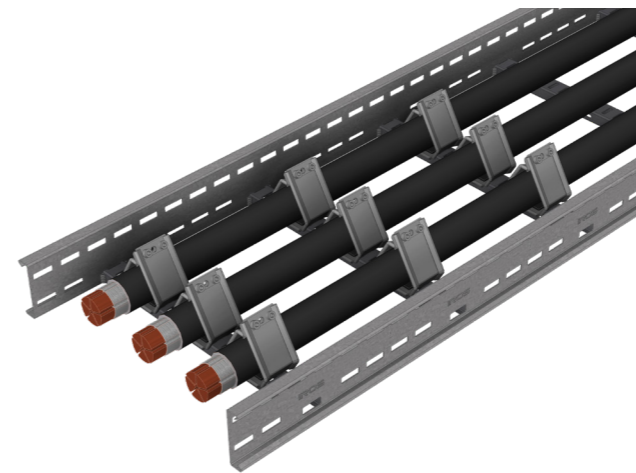
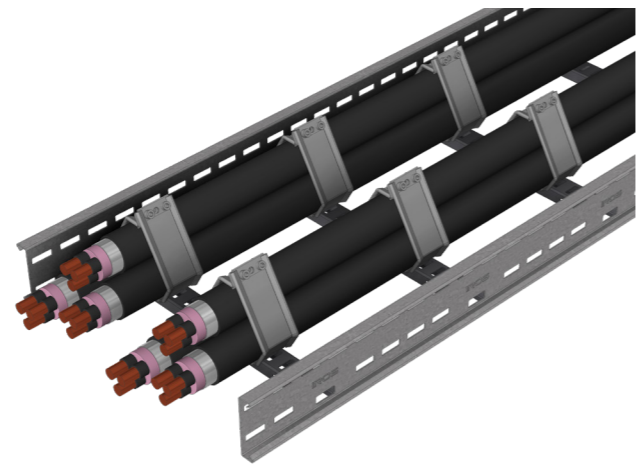
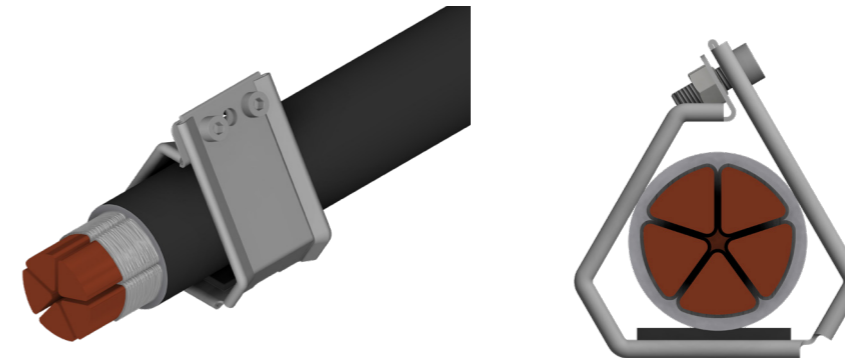
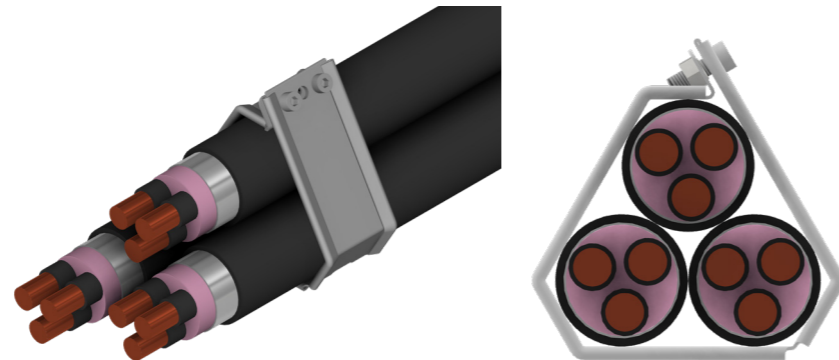

When installing the clamp on the cable ladder, the fixing kit is used CFC-FC-1-SS4

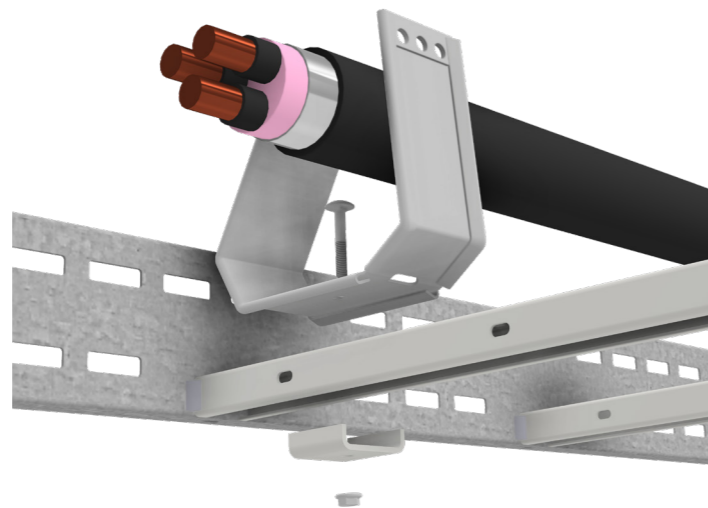

When installing the clamp on a console (bracket), the fixing kit is used CFC-FC-2-SS4

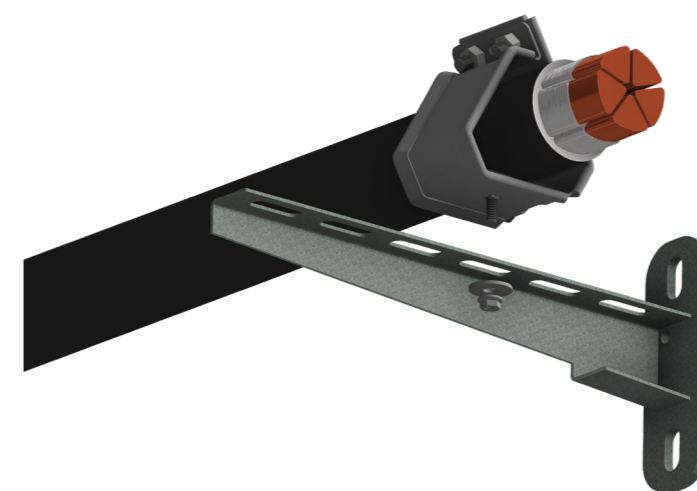

2	Ø,MM	Cable clamp CFC-S	SS4
1	37	CFC-S-37-SS4	7838131
2	39	CFC-S-39-SS4	7838132
3	41	CFC-S-41-SS4	7838133
4	43	CFC-S-43-SS4	7838134
5	45	CFC-S-45-SS4	7838135
6	47	CFC-S-47-SS4	7838136
7	49	CFC-S-49-SS4	7838137
8	51	CFC-S-51-SS4	7838138
9	53	CFC-S-53-SS4	7838139
10	55	CFC-S-55-SS4	7838140
11	57	CFC-S-57-SS4	7838141
12	59	CFC-S-59-SS4	7838142
13	61	CFC-S-61-SS4	7838143
14	63	CFC-S-63-SS4	7838144
15	65	CFC-S-65-SS4	7838145
16	67	CFC-S-67-SS4	7838146
17	69	CFC-S-69-SS4	7838147
18	71	CFC-S-71-SS4	7838148
19	73	CFC-S-73-SS4	7838149
20	75	CFC-S-75-SS4	7838150
21	77	CFC-S-77-SS4	7838151
22	79	CFC-S-79-SS4	7838152
23	81	CFC-S-81-SS4	7838153
24	83	CFC-S-83-SS4	7838154
25	85	CFC-S-85-SS4	7838155
26	87	CFC-S-87-SS4	7838156
27	89	CFC-S-89-SS4	7838157
28	91	CFC-S-91-SS4	7838158
29	93	CFC-S-93-SS4	7838159
30	95	CFC-S-95-SS4	7838160
31	97	CFC-S-97-SS4	7838161
32	99	CFC-S-99-SS4	7838162

3	Fixing kit	SS4
1	CFC-FC-1-SS4	78381103
2	CFC-FC-2-SS4	78381104

Note:
Cable clamp CFC-S for cable diameters of 81 mm and larger, fixed to the support with two fixing kits (2 pcs.)

Designation structure			
series	element type	diameter, mm	material
CFC	S	53	SS4
CFC	T	45	SS4
Title			
Cable clamp CFC-S-53-SS4			
Cable clamp CFC-T-45-SS4			

Accepted symbols:
SS4 - stainless steel, resistance class D*

*corrosion resistance classification GOST R 52868-2021

Products



Support system



Cable system

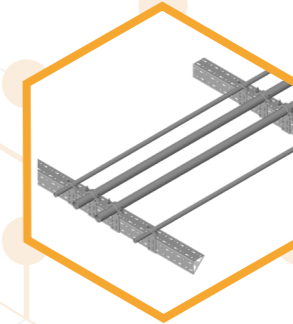

Supports and fastenings for pipelines

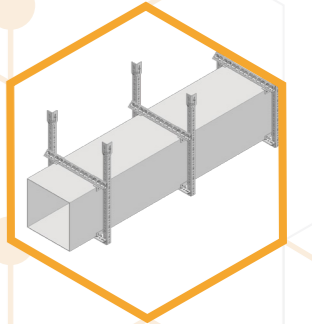

Supports for HVAC

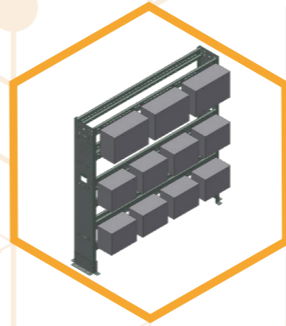

Equipment racks

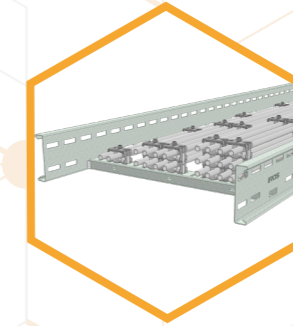

Tubing and clamps for hydraulic/pneumatic systems

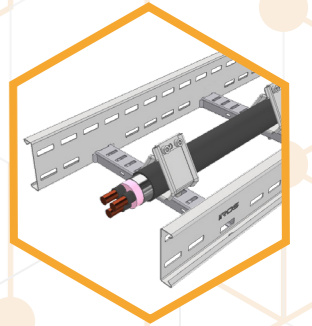

Cable fastening systems



Service platforms



OOO "IROS-SYSTEM"
195220, Russia,
Saint-Petersburg,
Phone: +7 (812) 701-00-31
E-mail: info@iros-system.com
www.iros-system.com

1.11.2023